



SUPERIOR

2022 PRODUCT CATALOG

The Superior Choice in Irrigation



Rich in History

Superior is the evolution of three highly regarded irrigation brands: Buckner, Superior Controls, and Western Brass Works. Our history extends back over a century to when Buckner was founded in Fresno, California. Since our beginnings we have been innovators in the irrigation industry and integral to the maintenance and beautification of landscapes and crop production across America.

In 1912 William A. Buckner introduced a patented slow-rotation sprinkler and founded the company that bears his name. Buckner continued to revolutionize the industry with new products such as the first hose-less irrigation system, the quick coupler valve, the hose swivel, the sand-resistant sprinkler bearing and a cam-drive sprinkler. The famous Pebble Beach Golf Course was an early installation site of Buckner's innovative automated irrigation systems. In 1998 Buckner was purchased by the Storm Family and became part of Storm Manufacturing Group.

In 1949, Allen and Powell Greenland founded Superior Controls Company in Los Angeles, California. Together they introduced the first solenoid-electric adaptor to convert manually operated anti-siphon valves to automatic operation. The pair also innovated the first diaphragm operated remote-control valve for the irrigation industry. Superior Controls became part of Storm Manufacturing Group in 2006.

Western Brass Works, now known as Storm Manufacturing Group, dates to the early stages of the irrigation industry. In 1932, Walter Storm purchased a brass foundry in the City of Los Angeles. Eventually his foundry became a key supplier to many companies in the fledgling irrigation industry. In addition to supplying brass castings and machine parts to his competitors, Walter's Western Brass Works became a leading innovator in agricultural irrigation, receiving numerous patents for their unique technological advancements.

For almost a century the Storm Family has manufactured quality products under the brands of Western Brass Works, WestAg, Imperial, Western Raintrol and Storm Irrigation. These brands, together with Buckner and Superior Controls, have grown and evolved to become consolidated under the Superior brand. Today our products continue to honor the legacy of our founders through their performance, dependability, reliability, innovation, and efficiency. Today we remain the Superior choice in irrigation.



Innovation Milestones



A close-up photograph of several green grass blades. The blades are vibrant green and have several clear water droplets of varying sizes on their surfaces. The background is a soft, out-of-focus light green, creating a fresh and natural atmosphere. The text is overlaid in white, centered on the left side of the image.

Efficient Irrigation Starts with Superior Design





Superior provides efficient irrigation solutions to help grow a healthier, greener landscape. Our products are designed for ease of installation and maintenance, durability, and reliability to save you time, energy, and money. Superior is the best choice for the rugged demands of your irrigation system.



Table of Contents

INLINE VALVES	8
SPV	9-10
450	11
950	12
950DW	13
950PRS	14
950A	15
VB	16
VBDW	17
100	18
PRS-MOD	19
Accessories / Solenoids / Internal Bleed Lever Assembly / SK Valve Key	20
MASTER VALVES	21
3000	22
3200	23
3200NXT	24
3100	25
3100PRS	26
3300	27
Solenoids	28
MANUAL VALVES	29
VBM	30
AV / AVU	31
ASV / ASVU / ASB / ASBU / ASVW / ASVUW	32
AVB / AVBU	33
Bent Nose / Inverted Nose / LK Bent Nose / LK Inverted Nose	34
Hose Bibb / VBH	35
SBV	36
ADAPTORS	37
800 / 800AS / 800EX / 800HP	38
2000 / 2000AS	39
600 / 600AS	40
850DI / 850DIAS / 850DIGB	41
QUICK COUPLERS	42
ACME Thread Low Profile Quick Coupler	43
QB 2 Piece Series / QB 1 Piece Series / QCV Series	44
QB44NPAT10 / QB44NPATAR10 / ACME Key	45
Buckner Quick Couplers Key & Hose Swivel Reference Chart	46 - 47
Buckner Quick Coupler Keys	48
CONTROLLERS	49
Sterling	50
Sterling / Pedestal	51



IMPACT SPRINKLERS	52
17023R	53
17023W	54
170W23R	55
170W23W	56
170W15RP	57
2000S	58 - 59
300SAX	60 - 61
350SAX	62 - 63
400S	64 - 65
AI120	66 - 67
90SD	68
65P / 90DZ	69
261SDX	70 - 71
360SAX	72 - 73
AI123	74 - 75

POP UP SPRINKLERS & NOZZLES	76
Gravity Return Sprinklers	77-78
CoalBrass Nozzles	79 -80
Nozzles & Drain Valves / Sprinkler Bases & Roller Bases / Spike Base	81

HOSE END	82
Hose & Pipe Fittings	83
Y Strainers / Accessories	84
Service Accessories / Pitot / Pressure Gauge / Nipple Extractor	

ANTI-SIPHON & HOSE END PRODUCTS	
CROSS REFERENCE	85 - 87

WARRANTY	88
-----------------------	-----------

The BUCKNER COLLECTION

INLINE VALVES

VB	16
VBDW	17

QUICK COUPLERS

ACME Thread Low Profile Quick Coupler	43
QB 2 Piece Series / QB 1 Piece Series / QCV Series	44
QB44NPAT10 / QB44NPATAR10 / ACME Key	45
Buckner Quick Couplers Key & Hose Swivel Reference Chart	46 - 47
Buckner Quick Coupler Keys	48

IMPACT SPRINKLERS

17023R	53
17023W	54
170W23R	55
170W23W	56
170W15RP	57
2000S	58 - 59
300SAX	60 - 61
350SAX	62 - 63
400S	64 - 65
AI120	66 - 67
90SD	68
65P / 90DZ	69
261SDX	70 - 71
360SAX	72 - 73
AI123	74 - 75





IN-LINE VALVES



SPV

Plastic In-Line Valve with Forward Flow Design

Features and Benefits

- Available in 1", 1 1/2", and 2"
- Low flow capability
- Self-cleaning scrubbing rod and filter system provides optimal protection against particles entering the diaphragm chamber
- Low seat design decreases pressure loss and improves flow
- Two-piece internal assembly protects diaphragm
- Internal and External bleed
- Glass-filled nylon body
- 600 lb. test nylon reinforced EPDM diaphragm
- Coil can be rotated 360° and removed without removing solenoid operator
- Internal components interchangeable with Superior 950
- Flow rates as low as 0.25 GPM
- 5 Year Warranty

Operating Ranges

Flow: 0.25 to 200 GPM
 Pressure: 20 to 200 PSI
 Temperature: up to 150° F

Solenoid Specifications

Standard 24 VAC

In-rush current: 0.45 A (10.8 VA)
 Holding current: 0.30 A (7.2 VA)

Low Watt 24 VAC

In-rush current: 0.33 A (7.9 VA)
 Holding current: 0.20 A (4.9 VA)

Optional 110 VAC

In-rush current: 95 mA (10.5 VA)
 Holding current: 65 mA (7.2 VA)

Optional 220 VAC

In-rush current: 48 mA (10.5 VA)
 Holding current: 33 mA (7.2 VA)

Optional DC Latching

Pulse Range: 9 VDC to 24 VDC
 Pulse Width: 30 to 50 mS

Pressure Loss in PSI

GPM	SPV100	SPV150	SPV200
0.25	1.0		
0.5	1.3		
1	1.4		
2.5	1.5		
5	1.7		
10	1.9		
20	2.3	4.0	
30	5.1	4.2	
40	9.0	4.4	
50	13.9	4.5	4.3
75		5.4	4.7
100		9.9	5.4
125		14.4	8.4
150		20.9	11.9
175			16.1
200			19.8



Model Description

Model No.	Description	Height	Length
SPV100	1" In-Line Plastic Valve	5 1/2"	4 1/2"
SPV150	1 1/2" In-Line Plastic Valve	7 1/2"	6 1/2"
SPV200	2" In-Line Plastic Valve	8"	7"

*Optional PRS-MOD
 The PRS-MOD regulates outlet pressure at the valve regardless of incoming pressure fluctuation



*Optional Cross Handle
 Available with purple cross handle for reclaimed water identification. Add RW to model number



SPV

SPV Internal Features

Heavy Duty Flow Control Handle

Heavy duty brass cross handle allows for precise flow control

Internal Bleed

Internal Bleed manually operates the valve without discharging water into the valve box

EPDM Diaphragm

Offers long lasting performance in both potable and dirty/recycled water applications

Scrubbing Rod & Filter System

Self-cleaning scrubbing rod and filter system provides optimal protection against particles entering the diaphragm chamber

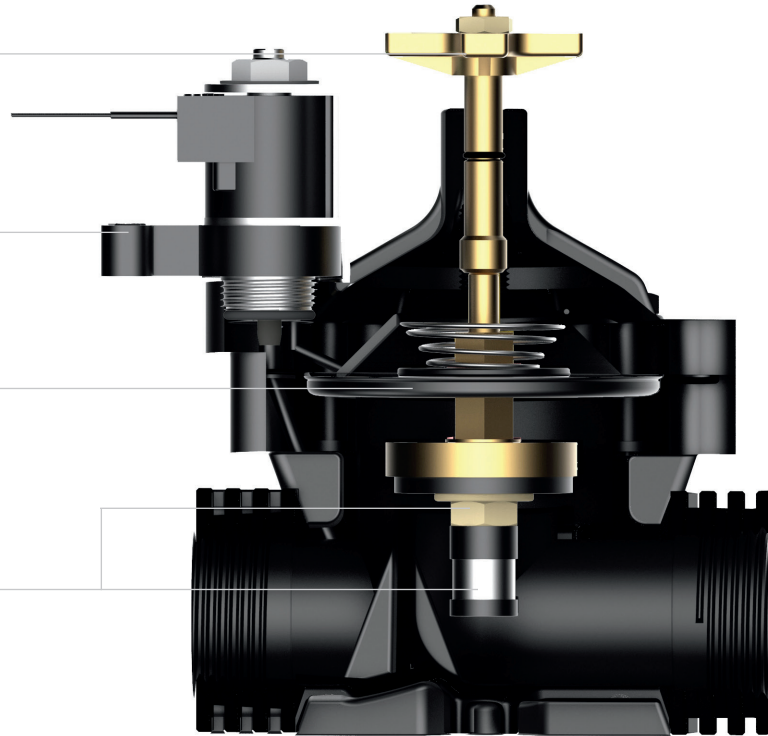

*Optional PRS-MOD

The PRS-MOD regulates outlet pressure at the valve regardless of incoming pressure fluctuation.



*Optional Cross Handle

Available with purple cross handle for reclaimed water identification. Add RW to model number.

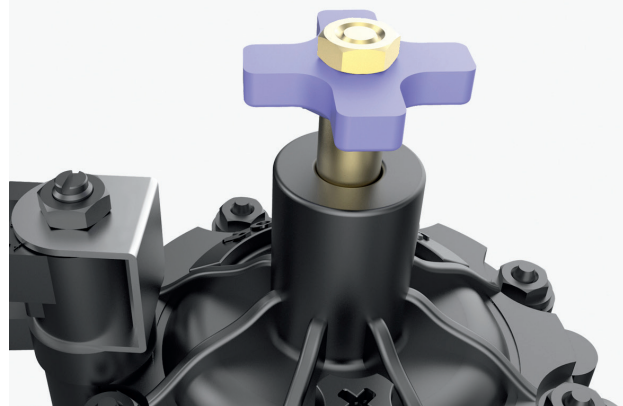

450

Plastic In-Line Valve with Forward Flow Design

Features and Benefits

- Available in 3/4" and 1"
- Molded from heavy-duty, high impact mineral-reinforced nylon material for maximum strength
- Internally molded brass screw inserts
- Includes an Internal Bleed control lever for manual operation
- Self-cleaning scrubber rod for protection against debris entering diaphragm chamber
- 600 lb. test nylon reinforced EPDM diaphragm
- 3 Year Warranty

Operating Ranges

Flow: 0.075 to 40 GPM
 Pressure: 20 to 150 PSI

Solenoid Specifications

Standard 24 VAC

In-rush current: 0.45 A (10.8 VA)
 Holding current: 0.30 A (7.2 VA)

Low Watt 24 VAC

In-rush current: 0.33 A (7.9 VA)
 Holding current: 0.20 A (4.9 VA)

Optional 110 VAC

In-rush current: 95 mA (10.5 VA)
 Holding current: 65 mA (7.2 VA)

Optional 220 VAC

In-rush current: 48 mA (10.5 VA)
 Holding current: 33 mA (7.2 VA)

Optional DC Latching

Pulse Range: 9 VDC to 24 VDC
 Pulse Width: 30 to 50 mS

Pressure Loss in PSI

GPM	Pressure Loss
5	0.04
10	0.06
15	1.00
20	1.90
25	2.90
30	4.18
35	5.91
40	7.62

Model Description

Model No.	Description
450075	3/4" In-Line Plastic Valve
450100	1" In-Line Plastic Valve



950

Brass In-Line Valve with Forward Flow Design

Features and Benefits

- Available in 3/4" to 3"
- Self-cleaning scrubber rod for protection against debris entering diaphragm chamber
- Low seat design decreases pressure loss and improves flow
- Two-piece internal assembly protects diaphragm
- 600 lb. test nylon reinforced EPDM diaphragm
- Made of high-quality Red Brass
- Coil can be rotated 360° and removed without removing solenoid operator
- Consistent design ensures backward compatibility
- External bleed for manual operation

Operating Ranges

Flow: 5 to 320 GPM
 Pressure: 20 to 200 PSI
 Temperature: 180° F

Solenoid Specifications

Standard 24 VAC

In-rush current: 0.45 A (10.8 VA)
 Holding current: 0.30 A (7.2 VA)

Low Watt 24 VAC

In-rush current: 0.33 A (7.9 VA)
 Holding current: 0.20 A (4.9 VA)

Optional 110 VAC

In-rush current: 95 mA (10.5 VA)
 Holding current: 65 mA (7.2 VA)

Optional 220 VAC

In-rush current: 48 mA (10.5 VA)
 Holding current: 33 mA (7.2 VA)

Optional DC Latching

Pulse Range: 9 VDC to 24 VDC
 Pulse Width: 30 to 50 mS

Pressure Loss in PSI

GPM	3/4"	1"	1 1/4"	1 1/2"	2"	2 1/2"	3"
5	0.5	0.2					
10	1.8	0.8					
15	4	1.5	0.5				
20	7	2.6	0.9	0.5			
30		5.7	1.9	1			
40		10	3.5	1.7	0.5		
50			5.3	2.7	0.8		
60			7.6	3.8	1.2		
70			10.1	5.1	1.6		
80				6.6	2.1		
90				8.3	2.6		
100				10.9	3.2	2.4	2.4
120					4.6	2.5	2.5
140					6.3	2.5	2.5
160					8	2.9	2.9
200					13.9	4	4
240						6	6
260						8.2	8.2
320						10.7	10.7



Model Description

Model No.	Description	Height	Length
950075	3/4" In-Line Brass Valve	4 3/32"	3 11/16"
950100	1" In-Line Brass Valve	5 15/16"	4 13/32"
950125	1 1/4" In-Line Brass Valve	5 19/32"	4 3/4"
950150	1 1/2" In-Line Brass Valve	7 5/32"	5 19/32"
950200	2" In-Line Brass Valve	7 5/32"	5 19/32"
950250	2 1/2" In-Line Brass	11 3/4"	9 13/16"
950300	3" In-Line Brass Valve	11 3/4"	9 13/16"
Options	BSPT available upon request		

*Optional PRS-MOD

The PRS-MOD regulates outlet pressure at the valve regardless of incoming pressure fluctuation.



*Optional Cross Handle

Available with purple cross handle for reclaimed water identification. Add RW to model number



950DW

Brass In-Line Dirty Water Valve with Forward Flow Design

Features and Benefits

- Available in 3/4" to 3"
- Self-cleaning scrubber rod and filter system for protection against debris entering diaphragm chamber
- Low seat design decreases pressure loss and improves flow
- Two-piece internal assembly protects diaphragm
- 600 lb. test nylon reinforced EPDM diaphragm
- Made of high-quality Red Brass
- Coil can be rotated 360° and removed without removing solenoid operator
- Consistent design ensures backward compatibility
- External bleed for manual operation

Operating Ranges

Flow: 5 to 320 GPM
 Pressure: 20 to 200 PSI
 Temperature: 180° F

Solenoid Specifications

Standard 24 VAC

In-rush current: 0.45 A (10.8 VA)
 Holding current: 0.30 A (7.2 VA)

Optional Low Watt 24 VAC

In-rush current: 0.33 A (7.9VA)
 Holding current: 0.20 A (4.9 VA)

Optional 110 VAC

In-rush current: 95 mA (10.5 VA)
 Holding current: 65 mA (7.2 VA)

Optional 220 VAC

In-rush current: 48 mA (10.5 VA)
 Holding current: 33 mA (7.2 VA)

Pressure Loss in PSI

GPM	3/4"	1"	1 1/4"	1 1/2"	2"	2 1/2"	3"
5	0.5	0.2					
10	1.8	0.8	0.5				
15	4	1.5	0.9				
20	7	2.6	1.9	0.5			
30		5.7	3.5	1			
40		10	5.3	1.7	0.5		
50			7.6	2.7	0.8		
60			10.1	3.8	1.2		
70				5.1	1.6		
80				6.6	2.1		
90				8.3	2.6		
100				10.9	3.2	2.4	2.4
120					4.6	2.5	2.5
140					6.3	2.5	2.5
160					8	2.9	2.9
200					13.9	4	4
240						6	6
260						8.2	8.2
320						10.7	10.7



Model Description

Model No.	Description	Height	Length
950DW075	3/4" In-Line Brass Valve	4 3/32"	3 11/16"
950DW100	1" In-Line Brass Valve	5 15/16"	4 13/32"
950DW125	1 1/4" In-Line Brass Valve	5 19/32"	4 3/4"
950DW150	1 1/2" In-Line Brass Valve	7 5/32"	5 19/32"
950DW200	2" In-Line Brass Valve	7 5/32"	5 19/32"
950DW250	2 1/2" In-Line Brass Valve	11 3/4"	9 13/16"
950DW300	3" In-Line Brass Valve	11 3/4"	9 3/16"
Options	BSPT available upon request		

*Optional PRS-MOD
 The PRS-MOD regulates outlet pressure at the valve regardless of incoming pressure fluctuation



*Optional Cross Handle
 Available with purple cross handle for reclaimed water identification. Add RW to model number



950PRS

Brass In-Line Valve with Pressure Regulation

Features and Benefits

- Available in 3/4" to 3"
- Self-cleaning scrubber rod and filter system for protection against debris entering diaphragm chamber
- Low seat design decreases pressure loss and improves flow
- Two-piece internal assembly protects diaphragm
- Pressure regulation is maintained during manual operation
- Internal bleed for manual operation
- 600 lb. test nylon reinforced EPDM diaphragm
- Made of high-quality Red Brass
- Coil can be rotated 360° and removed without removing solenoid operator
- Consistent design ensures backward compatibility
- Integrated Pressure Regulation Module maintains constant pressure between 10 and 125 PSI
- Fitted with Schrader valve for use with pressure gauge

Operating Ranges

Flow: 5 to 320 GPM
 Pressure: 20 to 200 PSI
 Temperature: 180° F

Solenoid Specifications

Standard 24 VAC

In-rush current: 0.45 A (10.8 VA)
 Holding current: 0.30 A (7.2 VA)

Low Watt 24 VAC

In-rush current: 0.33 A (7.9 VA)
 Holding current: 0.20 A (4.9 VA)

Optional 110 VAC

In-rush current: 95 mA (10.5 VA)
 Holding current: 65 mA (7.2 VA)

Optional 220 VAC

In-rush current: 48 mA (10.5 VA)
 Holding current: 33 mA (7.2 VA)

Pressure Loss in PSI

Size	3/4"	1"	1 1/4"	1 1/2"	2"	2 1/2"	3"
5	0.5	0.2					
10	1.8	0.8					
15	4	1.5	0.5				
20	7	2.6	0.9	0.5			
30		5.7	1.9	1			
40		10	3.5	1.7	0.5		
50			5.3	2.7	0.8		
60			7.6	3.8	1.2		
70			10.1	5.1	1.6		
80				6.6	2.1		
90				8.3	2.6		
100				10.9	3.2	2.4	2.4
120					4.6	2.5	2.5
140					6.3	2.5	2.5
160					8	2.9	2.9
200					13.9	4	4
240						6	6
260						8.2	8.2
320						10.7	10.7



Model Description

Model No.	Description	Height	Length
950PRS075	3/4" In-Line Brass Valve	4 3/32"	3 11/16"
950PRS100	1" In-Line Brass Valve	5 15/16"	4 13/32"
950PRS125	1 1/4" In-Line Brass Valve	5 19/32"	4 3/4"
950PRS150	1 1/2" In-Line Brass Valve	7 5/32"	5 19/32"
950PRS200	2" In-Line Brass Valve	7 5/32"	5 19/32"
950PRS250	2 1/2" In-Line Brass Valve	11 3/4"	9 13/16"
950PRS300	3" In-Line Brass Valve	11 3/4"	9 13/16"
Options	BSPT available upon request		

*Optional Cross Handle
 Available with purple cross handle for reclaimed water identification. Add RW to model number



950A

Brass Angle Valve with Forward Flow Design

Features and Benefits

- Available in 1", 1 1/2", and 2"
- Self-cleaning scrubber rod for protection against debris entering diaphragm chamber
- Low seat design decreases pressure loss and improves flow
- Two-piece internal assembly protects diaphragm
- 600 lb. test nylon reinforced EPDM diaphragm
- Coil can be rotated 360° and removed without removing solenoid operator
- Consistent design ensures backward compatibility
- Made of high-quality Red Brass
- External bleed for manual operation

Operating Ranges

Flow: 5 to 200 GPM
 Pressure: 20 to 200 PSI
 Temperature: 180° F

Solenoid Specifications

Standard 24 VAC

In-rush current: 0.45 A (10.8 VA)
 Holding current: 0.30 A (7.2 VA)

Low Watt 24 VAC

In-rush current: 0.33 A (7.9 VA)
 Holding current: 0.20 A (4.9 VA)

Optional 110 VAC

In-rush current: 95 mA (10.5 VA)
 Holding current: 65 mA (7.2 VA)

Optional 220 VAC

In-rush current: 48 mA (10.5 VA)
 Holding current: 33 mA (7.2 VA)

Optional DC Latching

Pulse Range: 9 VDC to 24 VDC
 Pulse Width: 30 to 50 mS

Pressure Loss in PSI

GPM	1"	1 1/2"	2"
10	0.8		
15	1.6		
20	2.6		
30	5.7		
40	10	0.5	0.5
50	16	0.8	0.8
60		1.2	1.2
70		1.6	1.6
80		2.1	2.1
90		2.6	2.6
100		3.2	3.2
120		4.6	4.6
140		6.3	6.3
160		8	8
200		13.9	13.9



Model Description

Model No.	Description	Height	Length	Width
950A100	1" In-Line Brass Angle Valve	7"	4 3/4"	3"
950A150	1 1/2" In-Line Brass Angle Valve	8 1/4"	5 1/2"	4 3/4"
950A200	2" In-Line Brass Angle Valve	8 1/4"	5 1/2"	4 3/4"
Options	BSPT available upon request			

*Optional Cross Handle
 Available with purple cross handle for reclaimed water identification. Add RW to model number



Reverse Flow In-Line Valves | VB

VB

Brass In-Line Valve with Reverse Flow Design

Features and Benefits

- Available in 3/4" to 2"
- Normally closed, reverse flow design ensures valve remains closed in the event of a diaphragm tear or puncture
- External bleed for manual operation
- Consistent slow and smooth closing speed reduces water hammer and prolongs valve life
- 600 lb. test nylon reinforced EPDM diaphragm
- Made of high-quality Red Brass

Operating Ranges

Flow: 5 to 140 GPM
 Pressure: 20 to 200 PSI
 Valve Closing Speed: 0.9 to 2.0 sec @ 50 to 100 PSI

Solenoid Specifications

Comes standard with:
 5.8 VA holding: (0.24 A at 24 VAC, 60 Hz)
 6.9 VA holding: (0.29 A at 24 VAC, 50 Hz)
 Coil Resistance (DC): 20 to 25 Ohms
 Min./Max. Voltage: 20/30 VAC

HD option comes with:
 7.5 VA holding: (0.32 A at 24 VAC, 60 Hz)
 9.0 VA holding: (0.38 A at 24 VAC, 50 Hz)
 Coil Resistance (DC): 18.8 Ohms
 Min./Max. Voltage: 20/30 VAC

Pressure Loss in PSI

GPM	VB07	VB10	VB12	VB15	VB20
5	3.6	3.3			
10	4.6	4.5	0.3		
15	4.8	4.7	0.7		
20	5.2	5.0	1.2		
25	6.6	5.8	1.7		
30	8.9	7.7	2.5		
35	10.0	9.6	2.8		
40		12.6	3.8		
45		16.3	5.1		
50			6.5	3.0	
55			7.6	3.7	
60			8.8	5.1	
70			9.7	7.6	3.0
80				10.2	3.4
90				13.0	4.2
100					4.8
120					6.7
140					7.2

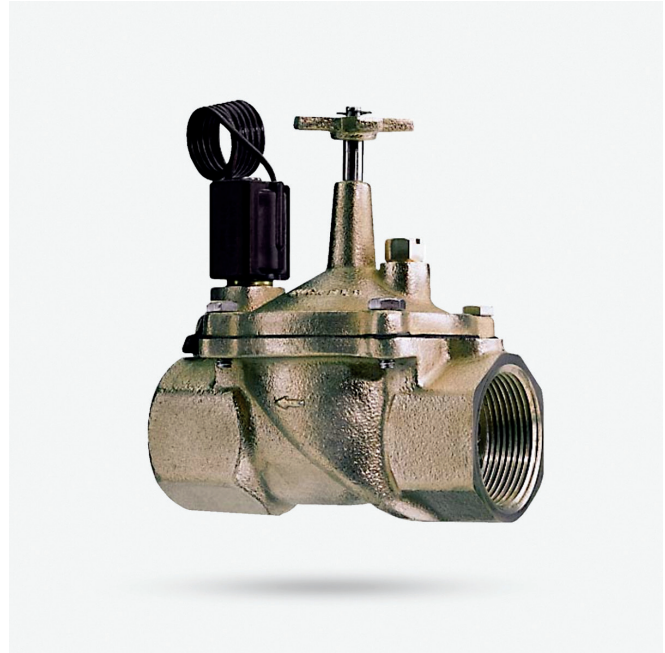

Model Description

Model No.	Description	Height	Length	Width
VB07	3/4" In-Line Brass Valve	5 1/4"	2 1/2"	4"
VB10	1" In-Line Brass Valve	5 1/4"	2 1/2"	4 1/2"
VB12	1 1/4" In-Line Brass Valve	5 1/4"	2 3/4"	4 7/8"
VB15	1 1/2" In-Line Brass Valve	6	3 3/4"	5"
VB20	2" In-Line Brass Valve	6 1/4"	5 7/8"	4 1/2"



VBDW

Brass In-Line Dirty Water Valve with Reverse Flow Design

Features and Benefits

- Available in 3/4" to 2"
- Normally closed, reverse flow design ensures valve remains closed in the event of a diaphragm tear or puncture
- External bleed for manual operation
- Consisted slow and smooth closing speed reduces water hammer
- 600 lb. test nylon reinforced EPDM diaphragm
- Non-continuous flow through the solenoid and valve orifices prevents clogging
- Made of high-quality Red Brass

Operating Ranges

Flow: 5 to 190 GPM
 Pressure: 10 to 200 PSI
 Valve Closing Speed: 0.9 to 2.0 sec @ 50 to 100 PSI

Solenoid Specifications

Comes standard with:
 8.5 VA holding: (0.35 A at 24 VAC, 60 Hz)
 10.2 VA holding: (0.42 A at 24 VAC, 50 Hz)
 Coil Resistance (DC): 18.8 Ohms
 Min./Max. Voltage: 20/30 VAC

Pressure Loss in PSI

GPM	VBDW07	VBDW10	VBDW12	VBDW15	VBDW20
5	0.5	0.4	0.2		
10	1.1	1.0	0.4	0.2	
15	2.4	2.0	0.8		
20	4.3	3.4	1.1	0.6	0.3
25	7.0	5.0	1.8		
30	10.9	7.3	2.5	1.2	0.6
35	14.	10.0	3.2		
40	18.7	12.9	4.3	2.0	0.9
45		16.2	5.4		
50		20.5	6.7	3.0	1.4
55			7.9		
60			9.5	4.0	1.9
65			11.2		
70			13.0	5.8	2.5
75			14.9		
80			17.1	7.5	3.2
90				9.6	4.2
100				11.6	5.1
110				14.0	6.2
120				16.8	7.3
130				20.0	8.6
140					9.9
150					11.2
160					12.9
170					14.8
180					16.5
190					19.0



Model Description

Model No.	Description	Height	Length	Width
VBDW07	3/4" In-Line Brass Valve	4 1/2"	4"	2 1/2"
VBDW10	1" In-Line Brass Valve	4 3/4"	4 1/4"	2 1/2"
VBDW12	1 1/4" In-Line Brass Valve	5 1/4"	4 7/8"	2 3/4"
VBDW15	1 1/2" In-Line Brass Valve	6"	5"	3 1/2"
VBDW20	2" In-Line Brass Valve	6 3/4"	6"	5"



100

Brass Normally Open Hydraulic Valve

Features and Benefits

- Available in 3/4" to 3"
- Normally open hydraulic valve design
- Low seat design decreases pressure loss and improves flow
- Two-piece internal assembly protects diaphragm
- 600 lb. test nylon reinforced EPDM diaphragm
- Made of high-quality Red Brass

Operating Ranges

Flow: 5 to 320 GPM

Pressure: 20 to 200 PSI

Pressure Loss in PSI

GPM	3/4"	1"	1 1/4"	1 1/2"	2"	2 1/2"	3"
5	0.5	0.2					
10	1.8	0.8					
15	4	1.5	0.5				
20	7	2.6	0.9	0.5			
30		5.7	1.9	1			
40		10	3.5	1.7	0.5		
50			5.3	2.7	0.8		
60			7.6	3.8	1.2		
70			10.1	5.1	1.6		
80				6.6	2.1		
90				8.3	2.6		
100				10.9	3.2	2.4	2.4
120					4.6	2.5	2.5
140					6.3	2.5	2.5
160					8	2.9	2.9
200					13.9	4	4
240						6	6
260						8.2	8.2
320						10.7	10.7

Model Description

Model No.	Description	Height	Length
100075	3/4" In-Line Brass Valve	4 3/32"	3 11/16"
100100	1" In-Line Brass Valve	5 15/16"	4 13/32"
100125	1 1/4" In-Line Brass Valve	5 19/32"	4 3/4"
100150	1 1/2" In-Line Brass Valve	7 5/32"	5 19/32"
100200	2" In-Line Brass Valve	7 5/32"	5 19/32"
100250	2 1/2" In-Line Brass Valve	11 3/4"	9 13/16"
100300	3" In-Line Brass Valve	11 3/4"	9 13/16"



*Optional Cross Handle
Available with purple cross handle for reclaimed water identification. Add RW to model number



PRS-MOD

Valve Pressure Regulating Module

Features and Benefits

- Compatible with the SPV, 950, and 800
- Regulates and maintains outlet pressure between 10 and 100 PSI
- Adjustment dial with increments of 5 PSI provides accurate pressure setting readout
- Consistent downstream pressure regulation reduces water hammer and pressure spikes
- Waterproof, corrosion-resistant dial housing eliminates fogging and binding
- Fitted with Schrader valve for pressure gauge verification
- Threads into valve solenoid port for easy field upgrade installation

Operating Ranges

Inlet Pressure: up to 200 PSI
 Pressure Regulation: 10 to 100 PSI
 Accuracy: + / - 3 PSI
 Flow: refer to chart
 Temperature: Up to 150°F

Recommended Flow Ranges

Valve Size	Flow Range
3/4"	5 to 20 GPM
1"	5 to 40 GPM
1 1/4"	15 to 70 GPM
1 1/2"	20 to 100 GPM
2"	40 to 200 GPM
2 1/2"	100 to 360 GPM
3"	100 to 360 GPM

Model Description

Model No.	Description
PRS-MOD	Pressure Regulating Module



In-Line Valves | Accessories



16200
24 VAC
In Rush Current: 0.45 A (10.8 VA)
Holding Current: 0.30 A (7.2 VA)
Compatible with: SPV, 450, 950



16304
Low Watt 24 VAC
In Rush Current: 0.33 A (7.9 VA)
Holding Current: 0.20 A (4.9 VA)
Compatible with: SPV, 450, 950



16275
110 VAC
In Rush Current: 95 mA (10.5 VA)
Holding Current: 65 mA (7.2 VA)
Compatible with: SPV, 450, 950



16302
220 VAC
In Rush Current: 95 mA (10.5 VA)
Holding Current: 65 mA (7.2 VA)
Compatible with: SPV, 450, 950



16305
DC Latching
Pulse Range: 9 VDC to 24 VDC
Pulse Width: 30 to 50 mS
Compatible with: SPV, 450, 950, 950A



VBPRASKIT
2-Way 24 VAC Solenoid Repair Kit



VBPRASHVKIT
115 VAC High Voltage Solenoid Assembly



VBPRASHDKIT
Heavy Duty Solenoid Assembly



VDWASKIT
3-Way Dirty Water Solenoid Assembly

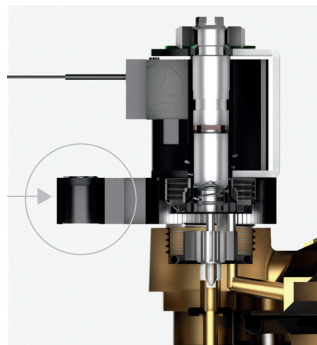

Internal Bleed Lever Assembly

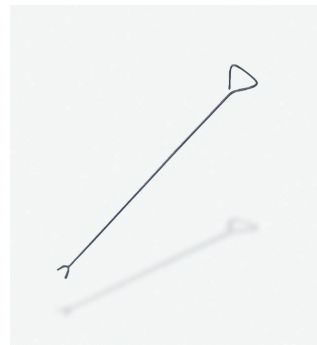

SK
Valve Key





MASTER VALVES



3000

Normally closed master valve with a 3-way solenoid that allows all water to be exhausted from the top of the diaphragm when the solenoid is energized. Excellent dirty water protection is afforded by the removable filter and non-continuous flow through the solenoid.

Features and Benefits

- Available in 1" to 3"
- External plumbing allows easy maintenance to filter assembly
- 600 lb. test nylon reinforced EPDM diaphragm
- Non-continuous flow through solenoid extends performance of filter assembly
- Reliable operation for dirty and recycled water applications

Operating Ranges

Flow: 5 to 320 GPM
 Pressure: 20 to 200 PSI

Solenoid Specifications

Standard 24 VAC

In-rush current: 0.45A (10.8 VA)
 Holding current: 0.30A (7.2 VA)

Optional 110 VAC

In-rush current: 95 mA (10.5 VA)
 Holding current: 65 mA (7.2 VA)

Optional DC Latching

Pulse Range: 9 VDC to 24 VDC
 Pulse Width: 30 to 50 mS

Pressure Loss in PSI

GPM	1"	1 1/4"	1 1/2"	2"	2 1/2"	3"
5	0.2					
10	0.8					
15	1.5	0.5				
20	2.6	0.9	0.5			
30	5.7	1.9	1			
40	10	3.5	1.7	0.5		
50		5.3	2.7	0.8		
60		7.6	3.8	1.2		
70		10.1	5.1	1.6		
80			6.6	2.1		
90			8.3	2.6		
100			10.9	3.2	2.4	2.4
120				4.6	2.5	2.5
140				6.3	2.5	2.5
160				8	2.9	2.9
200				13.9	4	4
240				6.3	6	6
260				8	8.2	8.2
320				13.9	10.7	10.7



Model Description

Model No.	Description	Height	Length
3000100	1" Normally Closed Master Valve	4 1/2"	4 3/8"
3000125	1 1/4" Normally Closed Master Valve	5 1/2"	5"
3000150	1 1/2" Normally Closed Master Valve	8"	6"
3000200	2" Normally Closed Master Valve	9"	7"
3000250	2 1/2" Normally Closed Master Valve	10"	11 5/8"
3000300	3" Normally Closed Master Valve	10"	11 5/8"
Options	BSPT available upon request		

*Optional Cross Handle
 Available with purple cross handle for reclaimed water identification. Add RW to model number



3200

Normally closed master valve that provides dirty and recycled water protection and has no minimum flow requirement. Reliably opens and closes regardless of system flow rate.

Features and Benefits

- Available in 3/4" to 3"
- No minimum flow requirement
- Dual chamber design provides no minimum flow capability
- External plumbing allows easy maintenance to filter assembly
- 600 lb. test nylon reinforced EPDM diaphragm
- Non-continuous flow through solenoid extends performance of filter assembly

Operating Ranges

Flow: 0 to 320 GPM
 Pressure: 20 to 200 PSI

Solenoid Specifications

Standard 24 VAC

In-rush current: 0.45 A (10.8 VA)
 Holding current: 0.30 A (7.2 VA)

Optional 110 VAC

In-rush current: 95 mA (10.5 VA)
 Holding current: 65 mA (7.2 VA)

Optional DC Latching

Pulse Range: 9 VDC to 24 VDC
 Pulse Width: 30 to 50 mS

Pressure Loss in PSI

GPM	3/4"	1"	1 1/4"	1 1/2"	2"	2 1/2"	3"
5	0.5	0.2					
10	1.7	0.8					
15	4	1.5	0.5				
20	7	2.6	0.9	0.5			
30		5.7	1.9	1			
40		10	3.5	1.7	0.5		
50			5.3	2.7	0.8		
60			7.6	3.8	1.2		
70			10.1	5.1	1.6		
80				6.6	2.1		
90				8.3	2.6		
100				10.9	3.2	2.4	2.4
120					4.6	2.5	2.5
140					6.3	2.5	2.5
160					8	2.9	2.9
200					13.9	4	4
240						6	6
260						8.2	8.2
320						10.7	10.7



Model Description

Model No.	Description	Height	Length
3200075	3/4" Normally Closed Master Valve	4 1/2"	4 3/8"
3200100	1" Normally Closed Master Valve	5 1/2"	5"
3200150	1 1/2" Normally Closed Master Valve	8"	6"
3200200	2" Normally Closed Master Valve	9"	7"
3200250	2 1/2" Normally Closed Master Valve	10"	11 5/8"
3200300	3" Normally Closed Master Valve	10"	11 5/8"
Options	BSPT available upon request		

*Optional Cross Handle
 Available with purple cross handle for reclaimed water identification. Add RW to model number



3200NXT

Normally closed master valve that provides dirty and recycled water protection and has no minimum flow requirement. Reliably opens and closes regardless of system flow rate. Incorporates a patented, internally routed 3-way solenoid eliminating the need for external tubing.

Features and Benefits

- Available in 3/4" to 3"
- Patented, internal 3-way solenoid; no external tubing
- Dual chamber design provides no minimum flow capability
- External plumbing allows easy maintenance of filter assembly
- 600 lb. test nylon reinforced EPDM diaphragm
- Non-continuous flow through solenoid extends performance of filter assembly

Operating Ranges

Flow: 0 to 320 GPM
Pressure: 20 to 200 PSI

Solenoid Specifications

Standard 24 VAC
In-rush current: 0.45A (10.8 VA)
Holding current: 0.30A (7.2 VA)

Optional 110 VAC
In-rush current: 95 mA (10.5 VA)
Holding current: 65 mA (7.2 VA)

Pressure Loss in PSI

GPM	3/4"	1"	1 1/4"	1 1/2"	2"	2 1/2"	3"
5	0.5	0.2					
10	1.7	0.8					
15	4	1.5	0.5				
20	7	2.6	0.9	0.5			
30		5.7	1.9	1			
40		10	3.5	1.7	0.5		
50			5.3	2.7	0.8		
60			7.6	3.8	1.2		
70			10.1	5.1	1.6		
80				6.6	2.1		
90				8.3	2.6		
100				10.9	3.2	2.4	2.4
120					4.6	2.5	2.5
140					6.3	2.5	2.5
160					8	2.9	2.9
200					13.9	4	4
240						6	6
260						8.2	8.2
320						10.7	10.7



Model Description

Model No.	Description
3200075NXT	3/4" Normally Closed Master Valve
3200100NXT	1" Normally Closed Master Valve
3200150NXT	1 1/2" Normally Closed Master Valve
3200200NXT	2" Normally Closed Master Valve
3200250NXT	2 1/2" Normally Closed Master Valve
3200300NXT	3" Normally Closed Master Valve
Options	BSPT available upon request

*Optional Cross Handle
Available with purple cross handle for reclaimed water identification. Add RW to model number



Master Valves | Normally Open

3100

Normally open master valve ideal for dirty and recycled water applications.

Features and Benefits

- Available in 3/4" to 3"
- Normally Open design allows for constant system pressurization
- On-demand access for manual irrigation and quick coupler use
- Low seat design decreases pressure loss and improves flow
- Self-cleaning inlet orifice with metering rod allows only "clean water" to enter upper diaphragm chamber offering consistent, trouble-free operation
- 600 lb. test nylon reinforced EPDM diaphragm
- Reliable operation for dirty and recycled water applications

Operating Ranges

Flow: 5 to 320 GPM
Pressure: 20 to 150 PSI

Solenoid Specifications

Standard 24 VAC

In-rush current: 0.45 A (10.8 VA)
Holding current: 0.30 A (7.2 VA)

Optional 110 VAC

In-rush current: 95 mA (10.5 VA)
Holding current: 65 mA (7.2 VA)

Pressure Loss in PSI

GPM	3/4"	1"	1 1/4"	1 1/2"	2"	2 1/2"	3"
5	0.5	0.2					
10	1.8	0.8					
15	4	1.5	0.5				
20	7	2.6	0.9	0.5			
30		5.7	1.9	1			
40		10	3.5	1.7	0.5		
50			5.3	2.7	0.8		
60			7.6	3.8	1.2		
70			10.1	5.1	1.6		
80				6.6	2.1		
90				8.3	2.6		
100				10.9	3.2	2.4	2.4
120					4.6	2.5	2.5
140					6.3	2.5	2.5
160					8	2.9	2.9
200					13.9	4	4
240						6	6
260						8.2	8.2
320						10.7	10.7



Model Description

Model No.	Description	Height	Length
3100075	3/4" Normally Open Master Valve	5"	3 1/4"
3100100	1" Normally Open Automatic Valve	4 1/2"	4 3/8"
3100125	1 1/4" Normally Open Automatic Valve	5 1/2"	5"
3100150	1 1/2" Normally Open Automatic Valve	8"	6"
3100200	2" Normally Open Automatic Valve	9"	7"
3100250	2 1/2" Normally Open Master Valve	10"	11 5/8"
3100300	3" Normally Open Master Valve	10"	11 5/8"
Options	BSPT available upon request		

*Optional Cross Handle
Available with purple cross handle for reclaimed water identification. Add RW to model number



3100PRS

Normally open master valve providing recycled water protection and pressure regulation.

Features and Benefits

- Available in 1" to 3"
- Two-piece upper diaphragm and lower seat assembly maximizes flow through valve and protects diaphragm from harmful debris
- Normally Open design allows for constant system pressurization
- On-demand access for manual irrigation and quick coupler use
- Can be regulated to maintain constant outlet pressure between 10 and 125 PSI
- Low seat design decreases pressure loss and improves flow
- Self-cleaning inlet orifice with metering rod allows only "clean water" to enter upper diaphragm chamber offering consistent, trouble-free operation
- 600 lb. test nylon reinforced EPDM diaphragm
- Reliable operation for dirty and recycled water applications

Operating Ranges

Flow: 0 to 320 GPM
 Pressure: 20 to 200 PSI

Solenoid Specifications

Standard 24 VAC

In-rush current: 0.45A (10.8 VA)
 Holding current: 0.30A (7.2 VA)

Optional 110 VAC

In-rush current: 95 mA (10.5 VA)
 Holding current: 65 mA (7.2 VA)

Pressure Loss in PSI

GPM	1"	1 1/4"	1 1/2"	2"	2 1/2"	3"
5	0.2					
10	0.8					
15	1.5	0.5				
20	2.6	0.9	0.5			
30	5.7	1.9	1			
40	10	3.5	1.7	0.5		
50		5.3	2.7	0.8		
60		7.6	3.8	1.2		
70		10.1	5.1	1.6		
80			6.6	2.1		
90			8.3	2.6		
100			10.9	3.2	2.4	2.4
120				4.6	2.5	2.5
140				6.3	2.5	2.5
160				8	2.9	2.9
200				13.9	4	4
240					6	6
260					8.2	8.2
320					10.7	10.7



Model Description

Model No.	Description
3100100PRS	1" Normally Open Pressure Regulating Master Valve
3100125PRS	1 1/4" Normally Open Pressure Regulating Master Valve
3100150PRS	1 1/2" Normally Open Pressure Regulating Master Valve
3100200PRS	2" Normally Open Pressure Regulating Master Valve
3100250PRS	2 1/2" Normally Open Pressure Regulating Master Valve
3100300PRS	3" Normally Open Pressure Regulating Master Valve
Options	BSPT available upon request

*Optional Cross Handle
 Available with purple cross handle for reclaimed water identification. Add RW to model number



3300

Normally open master valve that provides dirty and recycled water protection and has no minimum flow requirement. Reliably opens and closes regardless of system flow rate.

Features and Benefits

- Available in 1 1/2" to 3"
- Dual chamber design provides no minimum flow capability
- External plumbing allows easy maintenance of filter assembly
- 600 lb. test nylon reinforced EPDM diaphragm
- Non-continuous flow through solenoid extends performance of filter
- Normally Open design allows for constant system pressurization
- On-demand access for manual irrigation and quick coupler use

Operating Ranges

Flow: 0 to 320 GPM
 Pressure: 20 to 200 PSI

Solenoid Specifications

Standard 24 VAC
 In-rush current: 0.45 A (10.8 VA)
 Holding current: 0.30 A (7.2 VA)

Optional 110 VAC
 In-rush current: 95 mA (10.5 VA)
 Holding current: 65 mA (7.2 VA)

Pressure Loss in PSI

GPM	1 1/2"	2"	2 1/2"	3"
5				
10				
15				
20	0.5			
30	1			
40	1.7	0.5		
50	2.7	0.8		
60	3.8	1.2		
70	5.1	1.6		
80	6.6	2.1		
90	8.3	2.6		
100	10.9	3.2	2.4	2.4
120		4.6	2.5	2.5
140		6.3	2.5	2.5
160		8	2.9	2.9
200		13.9	4	4
240			6	6
260			8.2	8.2
320			10.7	10.7



Model Description

Model No.	Description
3300150	1 1/2" Normally Open Master Valve
3300200	2" Normally Open Master Valve
3300250	2 1/2" Normally Open Master Valve
3300300	3" Normally Open Master Valve
Options	BSPT threads available upon request

*Optional Cross Handle
 Available with purple cross handle for reclaimed water identification. Add RW to model number



Master Valves | Solenoids



16075-A
 24 VAC 3-Way
 In Rush Current: 0.45 A (10.8 VA)
 Holding Current: 0.30 A (7.2 VA)
 Compatible with: 3000, 3200, 3300



16075
 24 VAC 3-Way
 In Rush Current: 0.45 A (10.8 VA)
 Holding Current: 0.30 A (7.2 VA)
 Compatible with: 3100



16838
 Low Watt 24 VAC
 In Rush Current: 0.33 A
 Holding Current: 0.20 A
 Compatible with: 3000, 3200, 3300

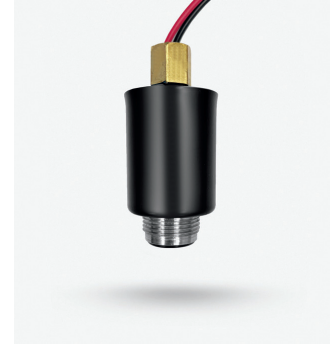

16333
 3-Way DC Latching
 Pulse Range: 9 VDC to 24 VDC
 Compatible with: 3000, 3200, 3300



16275
 110 VAC 3-Way
 In Rush Current: 95 mA (10.5 VA)
 Holding Current: 65 mA (7.2 VA)
 Compatible with: 3000, 3200, 3300



16303
 110 VAC 3-Way
 In Rush Current: 95 mA (10.5 VA)
 Holding Current: 65 mA (7.2 VA)
 Compatible with: 3100





MANUAL VALVES



Manual Valves | Angle Valves

VBM

Robust manual angle valve for demanding flow control applications

Features and Benefits

- Available in 3/4" to 2"
- Constructed from corrosion resistant, heavy duty red brass
- Thick wall construction resists damage from mechanical pipe loads
- Free-floating disc extends seal life
- Removable bonnet allows inline servicing of valve

Operating Ranges

Flow: 0 to 200 GPM
 Pressure: 200 PSI max

Pressure Loss in PSI

GPM	VBM07	VBM10	VBM12	VBM15	VBM20
10	0.5				
20	2.2	0.7			
40		2.5	0.7		0.2
60			1.4		0.4
80				1	0.9
100				2.1	1.3
125				2.6	1.9
150				3.7	2.7
175					3.7
200					4.7

Model Description

Model No.	Description	Height	Width	Length
VBM07	1" Angle Valve	5 3/4"	2 1/2"	2 1/4"
VBM10	1" Angle Valve	6 3/4"	2 3/4"	3"
VBM12	1 1/4" Angle Valve	8 1/4"	3 1/2"	3 1/4"
VBM15	1 1/2" Angle Valve	9 3/4"	5"	4 1/2"
VBM20	2" Angle Valve	11 1/4"	5 1/2"	4 1/2"



Manual Valves | Angle Valves



AV

High-Quality, Medium Duty Angle Valve

Features and Benefits

- Available in 3/4" to 2"
- Available in red brass or yellow brass
- Free-floating disc extends seal life
- Removable bonnet allows inline servicing of valve

Operating Ranges

Flow: 0 to 200 GPM
Pressure: 150 PSI max

Model Description

Model No.	Description
AV075	3/4" Red Brass Manual Angle Valve with Cross Handle
AV100	1" Red Brass Manual Angle Valve with Cross Handle
AV120	1 1/4" Red Brass Manual Angle Valve with Cross Handle
AV150	1 1/2" Red Brass Manual Angle Valve with Cross Handle
AV200	2" Red Brass Manual Angle Valve with Cross Handle
AV075Y	3/4" Yellow Brass Manual Angle Valve w/ Cross Handle
AV100Y	1" Yellow Brass Manual Angle Valve w/ Cross Handle
AV120Y	1 1/4" Yellow Brass Manual Angle Valve w/ Cross Handle
AV150Y	1 1/2" Yellow Brass Manual Angle Valve w/ Cross Handle
AV200Y	2" Yellow Brass Manual Angle Valve w/ Cross Handle



AVU

Model Description

Model No.	Description
AVU075	3/4" Red Brass Manual Angle Valve with Union
AVU100	1" Red Brass Manual Angle Valve with Union
AVU120	1 1/4" Red Brass Manual Angle Valve with Union
AVU150	1 1/2" Red Brass Manual Angle Valve with Union
AVU200	2" Red Brass Manual Angle Valve with Union
AVU075Y	3/4" Yellow Brass Manual Angle Valve with Union
AVU100Y	1" Yellow Brass Manual Angle Valve with Union
AVU120Y	1 1/4" Yellow Brass Manual Angle Valve with Union
AVU150Y	1 1/2" Yellow Brass Manual Angle Valve with Union
AVU200Y	2" Yellow Brass Manual Angle Valve with Union



Manual Valves | Anti-Siphon Valves



ASV



ASVU



ASB / ASBU



ASVW / ASVUW

Anti-Siphon Valves and Bodies for backflow prevention

Features & Benefits

- Available in 3/4" and 1"
- Available in red brass or yellow brass
- Uniform Plumbers Code (UPC) listed
- International Association of Plumbers and Mechanical Officials Approved (IAPMO)
- Low pressure loss body design
- Operating pressure 25 to 150 PSI

Model Description

ASV (anti-siphon valve)

Model No.	Description
ASV07	3/4" Red Brass Anti-Siphon Valve
ASV10	1" Red Brass Anti-Siphon Valve
ASV07Y	3/4" Yellow Brass Anti-Siphon Valve
ASV10Y	1" Yellow Brass Anti-Siphon Valve

ASVU (anti-siphon valve w/union)

Model No.	Description
ASVU07	3/4" Red Brass Anti-Siphon Valve with Union
ASVU10	1" Red Brass Anti-Siphon Valve with Union
ASVU07Y	3/4" Yellow Brass Anti-Siphon Valve with Union
ASVU10Y	1" Yellow Brass Anti-Siphon Valve with Union

ASVW / ASVUW (anti-siphon valve w/ wheel handle)

Model No.	Description
ASVW07Y	3/4" Yellow Brass with Wheel Handle
ASVW10Y	1" Yellow Brass with Wheel Handle
ASVUW07Y	3/4" Yellow Brass Union with Wheel Handle
ASVUW10Y	1" Yellow Brass Union with Wheel Handle

ASB (anti-siphon body)

Model No.	Description
ASB07	3/4" Red Brass Anti-Siphon Body
ASB10	1" Red Brass Anti-Siphon Body
ASB07Y	3/4" Yellow Brass Anti-Siphon Valve
ASB10Y	1" Yellow Brass Anti-Siphon Valve

ASBU (anti-siphon body w/union)

Model No.	Description
ASBU07	3/4" Red Brass Anti-Siphon Body with Union
ASBU10	1" Red Brass Anti-Siphon Body with Union
ASBU07Y	3/4" Yellow Brass Anti-Siphon Body with Union
ASBU10Y	1" Yellow Brass Anti-Siphon Body with Union





AVB

Atmospheric Vacuum Breakers

Features & Benefits

- Available in 3/4" to 2"
- Prevents the backflow of irrigation system water into the household supply
- UPC Listed and IAPMO Approved
- Operating pressure 25 to 150 PSI
- Available in red brass or yellow brass

Model Description

Model No.	Description
AVB07	3/4" Red Brass Atmospheric Vacuum Breaker
AVB10	1" Red Brass Atmospheric Vacuum Breaker
AVB12	1 1/4" Red Brass Atmospheric Vacuum Breaker
AVB15	1 1/2" Red Brass Atmospheric Vacuum Breaker
AVB20	2" Red Brass Atmospheric Vacuum Breaker
AVB07Y	3/4" Yellow Brass Atmospheric Vacuum Breaker
AVB10Y	1" Yellow Brass Atmospheric Vacuum Breaker
AVB12Y	1 1/4" Yellow Brass Atmospheric Vacuum Breaker
AVB15Y	1 1/2" Yellow Brass Atmospheric Vacuum Breaker
AVB20Y	2" Yellow Brass Atmospheric Vacuum Breaker



AVBU

Model Description

Model No.	Description
AVBU07	3/4" Red Brass Atmospheric Vacuum Breaker w/ Union
AVBU10	1" Red Brass Atmospheric Vacuum Breaker w/ Union
AVBU12	1 1/4" Red Brass Atmospheric Vacuum Breaker w/ Union
AVBU15	1 1/2" Red Brass Atmospheric Vacuum Breaker w/ Union
AVBU20	2" Red Brass Atmospheric Vacuum Breaker w/ Union
AVBU07Y	3/4" Yellow Brass Atmospheric Vacuum Breaker w/ Union
AVBU10Y	1" Yellow Brass Atmospheric Vacuum Breaker w/ Union
AVBU12Y	1 1/4" Yellow Brass Atmospheric Vacuum Breaker w/ Union
AVBU15Y	1 1/2" Yellow Brass Atmospheric Vacuum Breaker w/ Union
AVBU20Y	2" Yellow Brass Atmospheric Vacuum Breaker w/ Union



Manual Valves | Garden Valves



Bent Nose



Inverted Nose



LK Bent Nose



LK Inverted Nose

Bent Nose and Inverted Garden Valves available in Red Brass and Yellow Brass models.

Model Description

Model No.	Description	
B400	3/4" M x 1/2" F NPT	Red Brass Bent Nose
B401	3/4" M x 3/4" F NPT	Red Brass Bent Nose
B402	3/4" M x 1" F NPT	Red Brass Bent Nose
B400Y	3/4" M x 1/2" F NPT	Yellow Brass Bent Nose
B401Y	3/4" M x 3/4" F NPT	Yellow Brass Bent Nose
B402Y	3/4" M x 1" F NPT	Yellow Brass Bent Nose
I400	3/4" M x 1/2" F NPT	Red Brass Inverted Nose
I401	3/4" M x 3/4" F NPT	Red Brass Inverted Nose
I402	3/4" M x 1" F NPT	Red Brass Inverted Nose
I400Y	3/4" M x 1/2" F NPT	Yellow Brass Inverted Nose
I401Y	3/4" M x 3/4" F NPT	Yellow Brass Inverted Nose
I402Y	3/4" M x 1" F NPT	Yellow Brass Inverted Nose

Loose Key Bent and Inverted Nose Garden Valves available in Red Brass and Yellow Brass models

Model Description

Model No.	Description	
B401LK	3/4" M x 3/4" F NPT	Loose Key Bent Nose
B402LK	3/4" M x 1" F NPT	Loose Key Bent Nose
I401LK	3/4" M x 3/4" F NPT	Loose Key Inverted Nose
I402LK	3/4" M x 1" F NPT	Loose Key Inverted Nose





Hose Bibb

Available in several size configurations and Red Brass and Yellow Brass models

Model Description

Model No.	Description
HB1F	3/4" M x 1/2" F NPT Red Brass
HB1M	3/4" M x 1/2" M NPT Red Brass
HB2F	3/4" M x 3/4" F NPT Red Brass
HB2M	3/4" M x 3/4" M NPT Red Brass
HB1FY	3/4" M x 1/2" F NPT Yellow Brass
HB1MY	3/4" M x 1/2" M NPT Yellow Brass
HB2FY	3/4" M x 3/4" F NPT Yellow Brass
HB2MY	3/4" M x 3/4" M NPT Yellow Brass



VBH

Hose bibb vacuum breaker in 3/4" red brass

Model Description

Model No.	Description
VBH	3/4" Hose Bibb Vacuum Breaker



BSBV

Lead Free Brass Ball Valves

Features and Benefits

- Lead Free, Brass Body
- Full Port Body Design
- 600 WOG 150 WSP rating
- Female x Female NPT Ports
- Available sizes: 1/4" to 2", NPT

Operating Ranges

Max Pressure: 600 WOG

Max Temp: 400° F max

Model Description

Model No.	Description	Height	Length
BSBV025	1/4" NPT	1 5/8"	1 3/4"
BSBV038	3/8" NPT	1 5/8"	1 3/4"
BSBV050	1/2" NPT	1 55/64"	2 17/32"
BSBV075	3/4" NPT	2 1/64"	2 1/64"
BSBV100	1" NPT	2 29/64"	2 51/64"
BSBV125	1 1/4" NPT	3 1/64"	3 1/32"
BSBV150	1 1/2" NPT	3 17/32"	3 21/32"
BSBV200	2" NPT	4 3/8"	4 21/64"





ADAPTORS





800

800

Ideal for converting manual valves to automatic. Universal design fits a wide range of anti-siphon bodies.

Features and Benefits

- Available in 3/4" to 2"
- 600 lb. test nylon reinforced EPDM diaphragm
- Self-cleaning, dirt-free, clog-free design
- Slow closing: no water hammer, surge, or noise
- Flow control for regulating water from fully on to completely off
- Made of high-quality red brass

Operating Ranges

Pressure: 30 to 200 PSI

Solenoid Specifications

Standard 24 VAC

In-rush current: 0.45 A (10.8 VA)

Holding current: 0.30 A (7.2 VA)

Optional Low Watt 24 VAC

In-rush current: 0.33 A (7.9 VA)

Holding current: 0.20 A (4.9VA)

Optional 110 VAC

In-rush current: 95 mA (10.5 VA)

Holding current: 65 mA (7.2 VA)

Optional 220 VAC

In-rush current: 48 mA (10.5 VA)

Holding current: 33 mA (7.2 VA)

Optional DC Latching

Pulse Range: 9 VDC to 24 VDC

Pulse Width: 30 to 50 ms



800AS

Model Description

Model No.	Description
800075CH00	3/4" Automatic Brass Adaptor
800100CH00	1" Automatic Brass Adaptor
800125CH00	1 1/4" Automatic Brass Adaptor
800150CH00	1 1/2" Automatic Brass Adaptor
800200CH00	2" Automatic Brass Adaptor

800AS

Automatic brass adaptor installed with anti-siphon body

- IAPMO Certified and UPC Listed

800075AS	3/4" Automatic Brass Adaptor w/ anti-siphon
800100AS	1" Automatic Brass Adaptor w/ anti-siphon

800EX

Extended height adaptor for applications with insufficient spacing between anti-siphons to allow two 800s side by side.

800075CHEX	3/4" Automatic Brass Extension Adaptor
800100CHEX	1" Automatic Brass Extension Adaptor

800HP

Used to convert manual valves to automatic in systems with extremely high pressure.

- Will operate on pressure up to 300 PSI
- High torque assembly
- 7 watt solenoid

800075HP	3/4" Automatic Brass High Pressure Adaptor
800100HP	1" Automatic Brass High Pressure Adaptor





2000

Ideal for converting manual valves to automatic. Universal design fits a wide range of anti-siphon bodies.

Features and Benefits

- Available in 3/4" and 1"
- 600 lb. test nylon reinforced EPDM diaphragm
- Designed for tight-fitting installations
- Self-cleaning, dirt-free, clog-free design
- Slow closing: no water hammer, surge, or noise
- Flow control for regulating water from fully on to completely off
- Made of high-quality red brass

Operating Ranges

Pressure: 30 to 200 PSI

Solenoid Specifications

Standard 24 VAC

In-rush current: 0.45 A (10.8 VA)

Holding current: 0.30 A (7.2 VA)

Optional Low Watt 24 VAC

In-rush current: 0.33 A (7.9 VA)

Holding current: 0.20 A (4.9 VA)

Optional 110 VAC

In-rush current: 95 mA (10.5 VA)

Holding current: 65 mA (7.2 VA)

Optional 220 VAC

In-rush current: 48 mA (10.5 VA)

Holding current: 33 mA (7.2 VA)

Optional DC Latching

Pulse Range: 9 VDC to 24 VDC

Pulse Width: 30 to 50 mS



Model Description

Model No.	Description
2000075	3/4" Electric Compact Adaptor
2000100	1" Electric Compact Adaptor

2000AS

Automatic brass adaptor installed with anti-siphon body

- IAPMO Certified and UPC Listed

2000075AS	3/4" Automatic Brass Adaptor w/ anti-siphon
2000100AS	1" Automatic Brass Adaptor w/ anti-siphon





600

600

Ideal for converting manual valves to automatic. Universal design fits a wide range of anti-siphon bodies.

Features and Benefits

- Available in 3/4" and 1"
- Molded from heavy-duty, high-impact, glass-reinforced nylon
- 600 lb. test nylon reinforced EPDM diaphragm
- Self-cleaning, dirt-free, clog-free design
- Slow closing: no water hammer, surge, or noise
- Flow control for regulating water from fully on to completely off

Operating Ranges

Pressure: 30 to 200 PSI

Solenoid Specifications

Standard 24 VAC

In-rush current: 0.45 A (10.8 VA)

Holding current: 0.30 A (7.2 VA)

Optional Low Watt 24 VAC

In-rush current: 0.33 A (7.9 VA)

Holding current: 0.20 A (4.9 VA)

Optional 110 VAC

In-rush current: 95 mA (10.5 VA)

Holding current: 65 mA (7.2 VA)

Optional 220 VAC

In-rush current: 48 mA (10.5 VA)

Holding current: 33 mA (7.2 VA)

Optional DC Latching

Pulse Range: 9 VDC to 24 VDC

Pulse Width: 30 to 50 mS



600AS

Model Description

Model No.	Description
600075CH00	3/4" Electric Compact Plastic Adaptor
600100CH00	1" Electric Compact Plastic Adaptor

600AS

Automatic adaptor installed with anti-siphon body

- IAPMO Certified and UPC Listed

600075AS	3/4" Electric Compact Plastic Adaptor
600100AS	1" Electric Compact Plastic Adaptor



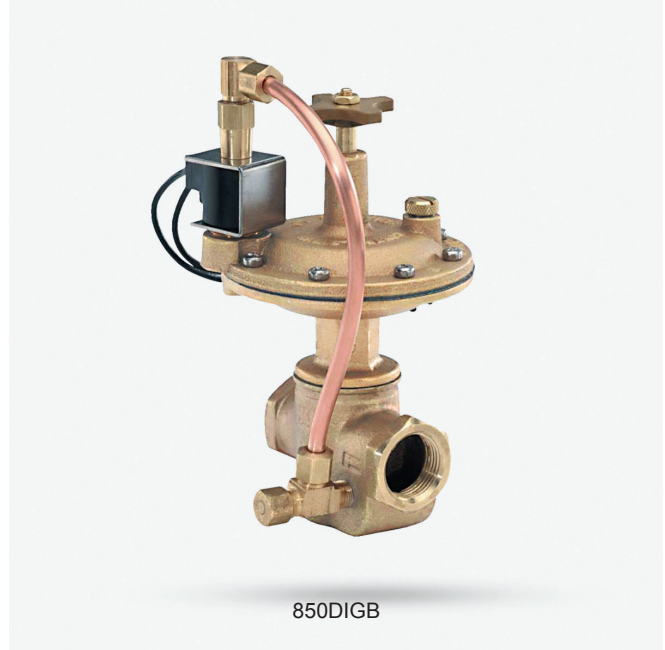

850DI

Specially designed to operate in low pressure, low flow, and excessive back pressure conditions. Ideal for drip irrigation.

Features and Benefits

- Available in 3/4" and 1"
- Made of high-quality red brass
- Allows complete opening and closing on flow as low as 1 gallon per hour
- Not affected by excessive back-pressure
- Available in Straight-thru or Anti-Siphon body design
- Slow closing: no water hammer, surge, or noise

Operating Ranges

Pressure: 30 to 200 PSI

Solenoid Specifications

Standard 24 VAC

In-rush current: 0.45 A (10.8 VA)

Holding current: 0.30 A (7.2 VA)

Optional 110 VAC

In-rush current: 95 mA (10.5 VA)

Holding current: 65 mA (7.2 VA)

Pressure Loss in PSI

GPM	3/4"	1"
5	0.5	0.2
10	1.6	0.6
15	3.2	1.2
20	5.6	2
25	9.5	4.4

850DIAS (anti-siphon)

Model Description

Model No.	Description
850DIAS075	3/4" Drip Irrigation Anti-Siphon Valve
850DIAS100	1" Drip Irrigation Anti-Siphon Valve

850DIGB (globe body)

Model Description

Model No.	Description
850DIGB075	3/4" Drip Irrigation Globe Valve
850DIGB100	1" Drip Irrigation Globe Valve





QUICK COUPLERS



Buckner Quick Couplers | Low Profile

ACME Thread Low Profile Quick Coupler

Low Profile Quick Coupling Valve is available with yellow or purple locking and non-locking lid options.

Features & Benefits

- Available in 1"
- The latest addition to the industry's broadest line of QC valves, keys and swivels
- Quick coupling valves, keys and hose swivels are fully interchangeable with the Signature Controls Series
- Superior internal components made from brass and stainless steel w/EPDM rubber parts

Model Description

Model No.	Description	Key
7642BS	1" NPT LP QC w/ Yellow Lid	7640BS or 7641BS
7643BS	1" NPT LP QC w/ Locking Yellow Lid	7640BS or 7641BS
7644BS	1" NPT LP QC w/ Purple Lid	7640BS or 7641BS
7645BS	1" NPT LP QC w/ Locking Purple Lid	7640BS or 7641BS

Compatible Keys

All keys are compatible with Buckner hose swivels.



7640BS

3/4" NPT Male x 1/2" Female, ACME Thread



7641BS

1" NPT Male x 3/4" Female, ACME Thread



Buckner Quick Couplers | Traditional



QB 2 Piece Series

Premium model for performance and serviceability.

Features & Benefits

- Available in 3/4" and 1"
- 2 piece body
- Locking lid option available (L)
- Anti-rotation option available (AR)

Model Description

Model No.	Size	Keys	Hose Swivel
QB33RC07 QB33LRC07	3/4"	QB33K07	HS075
QB44RC10 QB44LRC10 QB44RCAR10 QB44LRCAR10	1"	QB44K10	HS100/ HS101

Pressure Loss in PSI

GPM	All QB33 Series	All QB44 Series	All QB66 Series
5	0.8		
5	1.0		
10	2.0		
15	4.3		
20	7.6	1.0	0.7
30		3.9	3.0
40		8.3	4.5
50		13.9	8.2
60			10.3
70			14.2



QB 1 Piece Series

Ideal model for frequent water access.

Features & Benefits

- Available in 3/4" to 1 1/2"
- 1 piece body
- Locking lid option available (L)
- Anti-rotation option available (AR)

Model Description

Model No.	Size	Keys	Hose Swivel
QB3RC07 QB3LRC07	3/4"	QB33K07	HS075
QB5RC10 QB5LRC10 QB5SL10 QB5RCAR10 QB5LRCAR10	1"	QB55K10	HS100/ HS101
QB7RC15 QB7SL15 QB7LRC15	1" to 1 1/2"	QB7DK15	HS151

Pressure Loss in PSI

GPM	All QB3 Series	All QB5 Series	All QB7 Series
5	0.8		
10	1.8		
15	2.0		
20	4.1		
30	7.2	1.0	
40		3.0	
50		6.3	
60		9.2	2.8
70		13.0	3.6
80			4.9
90			6.6
100			11.0



QCV Series

Standard quick coupling valve model.

Features & Benefits

- Available in 3/4" to 1 1/2"
- 1 piece body
- Locking lid option available (L)

Model Description

Model No.	Size	Keys	Hose Swivel
QCV075 QCV075R QCV075RL	3/4"	QB33K07	HS075
QCV100 QCV100R QCV100RL	1"	QB44K10	HS100/ HS101
QCV151 QCV151R QCV151RL	1" to 1 1/2"	QC151	HS151





QB44NPAT10

The industry standard for recycled water sites.

Features & Benefits

- 2 piece body
- Locking purple lid
- ACME thread

Model Description

Model No.	Size	Keys	Hose Swivel
QB44NPAT10	1"	QB33K07	HS075



QB44NPATAR10

The industry standard quick coupler with anti-rotation.

Features & Benefits

- 2 piece body
- Locking purple lid
- ACME thread
- Anti-rotation wings

Model Description

Model No.	Size	Keys	Hose Swivel
QB44NPATAR10	1"	QB33K07	HS075



ACME Key

Features & Benefits

- 150+ PSI rated
- Locking purple lid
- English/Spanish



Buckner Quick Couplers | Key & Hose Swivel Reference Chart

Body Options					Lid Options			Key Options		
Model No.	Inlet Thread	Body Style (Pieces)	Slot Type	Anti-Rotation Wings	Color	Locking	Dimensions Height	Width	3/4" NPT Male x 1/2" Female	1" NPT Male x 3/4" Female
QCV075	3/4"	1	Single		Stainless		4 3/8"	2 3/8"	QB33K07	
QVC075R	3/4"	1	Single		Yellow		4 3/8"	2 3/8"	QB33K07	
QVC075RL	3/4"	1	Single		Yellow	Yes	4 3/8"	2 3/8"	QB33K07	
QVC075N	3/4"	1	Single		Purple	Yes	4 3/8"	2 3/8"	QB33K07	
QB3RC07	3/4"	1	Double		Yellow		4 3/8"	2 3/8"	QB33K07	
QB3LRC07	3/4"	1	Double		Yellow	Yes	4 3/8"	2 3/8"	QB33K07	
QB3NP07	3/4"	1	Double		Purple	Yes	4 3/8"	2 3/8"	QB33K07	
QB33RC07	1"	2	Double		Yellow		4 3/8"	2 3/8"	QB33K07	
QB33LRC07	1"	2	Double		Yellow	Yes	4 3/8"	2 3/8"	QB33K07	
QB33NP07	1"	2	Double		Purple	Yes	4 3/8"	2 3/8"	QB33K07	
QB5RC10	1"	1	Double		Yellow		5 3/8"	3 5/8"		QBS5K10
QB5SL10	1"	1	Double		Stainless		5 3/8"	3 5/8"		QBS5K10
QB5LRC10	1"	1	Double		Yellow	Yes	5 3/8"	3 5/8"		QBS5K10
QB5NP10	1"	1	Double		Purple	Yes	5 3/8"	3 5/8"		QBS5K10
QCV100	1"	1	Single		Stainless		5 3/8"	3 5/8"		QBS5K10
QVC100R	1"	1	Single		Yellow		5 3/8"	3 5/8"		QBS5K10
QVC100RL	1"	1	Single		Yellow	Yes	5 3/8"	3 5/8"		QBS5K10
QVC100N	1"	1	Single		Purple	Yes	5 3/8"	3 5/8"		QBS5K10
QVC101	1"	1	Double		Stainless		5 1/2"	4"		
QVC101R	1"	1	Double		Yellow		5 1/2"	4"		
QVC101RL	1"	1	Double		Yellow	Yes	5 1/2"	4"		
QVC101N	1"	1	Double		Purple	Yes	5 1/2"	4"		
QBRB5RC10	1"	1	Double		Yellow		5 3/8"	3 5/8"		
QBRB5LRC10	1"	1	Double		Yellow	Yes	5 3/8"	3 5/8"		
QBRB5NP10	1"	1	Double		Purple	Yes	5 3/8"	3 5/8"		
QB5RCAR10	1"	1	Double	Yes	Yellow		6"	8"		QBS5K10
QB5LRCAR10	1"	1	Double	Yes	Yellow	Yes	6"	8"		QBS5K10
QB5NPAR10	1"	1	Double	Yes	Purple	Yes	6"	8"		QBS5K10
QB44RC10	1"	2	Single		Yellow		5 3/8"	3 5/8"		QBS5K10
QB44LRC10	1"	2	Single		Yellow	Yes	5 3/8"	3 5/8"		QBS5K10
QB44NP10	1"	2	Single		Purple	Yes	5 3/8"	3 5/8"		QBS5K10
QB44RCAR10	1"	2	Single	Yes	Yellow		6"	8"		QBS5K10
QB44LRCAR10	1"	2	Single	Yes	Yellow	Yes	6"	8"		QBS5K10
QB44NPAR10	1"	2	Single	Yes	Purple	Yes	6"	8"		QBS5K10
QB44RCAT10	1"	2	ACME		Yellow		5 3/8"	3 5/8"		
QB44NPAT10	1"	2	ACME		Purple	Yes	5 3/8"	3 5/8"		
QB44RCATAR10	1"	2	ACME	Yes	Yellow		6"	8"		
QB44LRCATAR10	1"	2	ACME	Yes	Yellow	Yes	6"	8"		
QB44NPATAR10	1"	2	ACME	Yes	Purple	Yes	6"	8"		
QCV151	1 1/2"	1	Single		Stainless		5 1/2"	4"		
QCV151R	1 1/2"	1	Single		Yellow		5 1/2"	4"		
QCV151RL	1 1/2"	1	Single		Yellow	Yes	5 1/2"	4"		
QCV151N	1 1/2"	1	Single		Purple	Yes	5 1/2"	4"		
QB7RC15	1 1/2"	1	Single		Yellow		5 7/8"	3 7/8"		
QB7SL15	1 1/2"	1	Single		Stainless		5 7/8"	3 7/8"		
QBLRC15	1 1/2"	1	Single		Yellow	Yes	5 7/8"	3 7/8"		
QB7NP15	1 1/2"	1	Single		Purple	Yes	5 7/8"	3 7/8"		



Buckner Quick Couplers | Key & Hose Swivel Reference Chart

Key Options

Hose Swivel Options

Model No.	1" NPT Female (For Sprinkler Only)	ACME Thread 1" Male x 3/4" Female	3/4" Male Hose (MHT) x 3/4" Female Pipe (FPT)	3/4" Male Hose (MHT) x 1" Female Pipe (FPT)	1" Male Hose (MHT) x 1" Female Pipe (FPT)	1" Male Hose (MHT) x 1 1/2" Female Pipe (FPT)
QCV075			HS075			
QVC075R			HS075			
QVC075RL			HS075			
QVC075N			HS075			
QB3RC07			HS075			
QB3LRC07			HS075			
QB3NP07			HS075			
QB33RC07			HS075			
QB33LRC07			HS075			
QB33NP07			HS075			
QB5RC10				HS100	HS101	
QB5SL10				HS100	HS101	
QB5LRC10				HS100	HS101	
QB5NP10				HS100	HS101	
QCV100	QCS100			HS100	HS101	
QVC100R	QCS100			HS100	HS101	
QVC100RL	QCS100			HS100	HS101	
QVC100N	QCS100			HS100	HS101	
QVC101				HS100	HS101	
QVC101R				HS100	HS101	
QVC101RL				HS100	HS101	
QVC101N				HS100	HS101	
QBRB5RC10				HS100	HS101	
QBRB5LRC10				HS100	HS101	
QBRB5NP10				HS100	HS101	
QB5RCAR10				HS100	HS101	
QB5LRCAR10				HS100	HS101	
QB5NPAR10				HS100	HS101	
QB44RC10	QCS100			HS100	HS101	
QB44LRC10	QCS100			HS100	HS101	
QB44NP10	QCS100			HS100	HS101	
QB44RCAR10	QCS100			HS100	HS101	
QB44LRCAR10	QCS100			HS100	HS101	
QB44NPAR10	QCS100			HS100	HS101	
QB44RCAT10		QBSRK10		HS100	HS101	
QB44NPAT10		QBSRK10		HS100	HS101	
QB44RCATAR10		QBSRK10		HS100	HS101	
QB44LRCATAR10		QBSRK10		HS100	HS101	
QB44NPATAR10		QBSRK10		HS100	HS101	
QCV151						HS151
QCV151R						HS151
QCV151RL						HS151
QCV151N						HS151
QB7RC15						HS151
QB7SL15						HS151
QBLRC15						HS151
QB7NP15						HS151



Buckner Quick Couplers | Keys

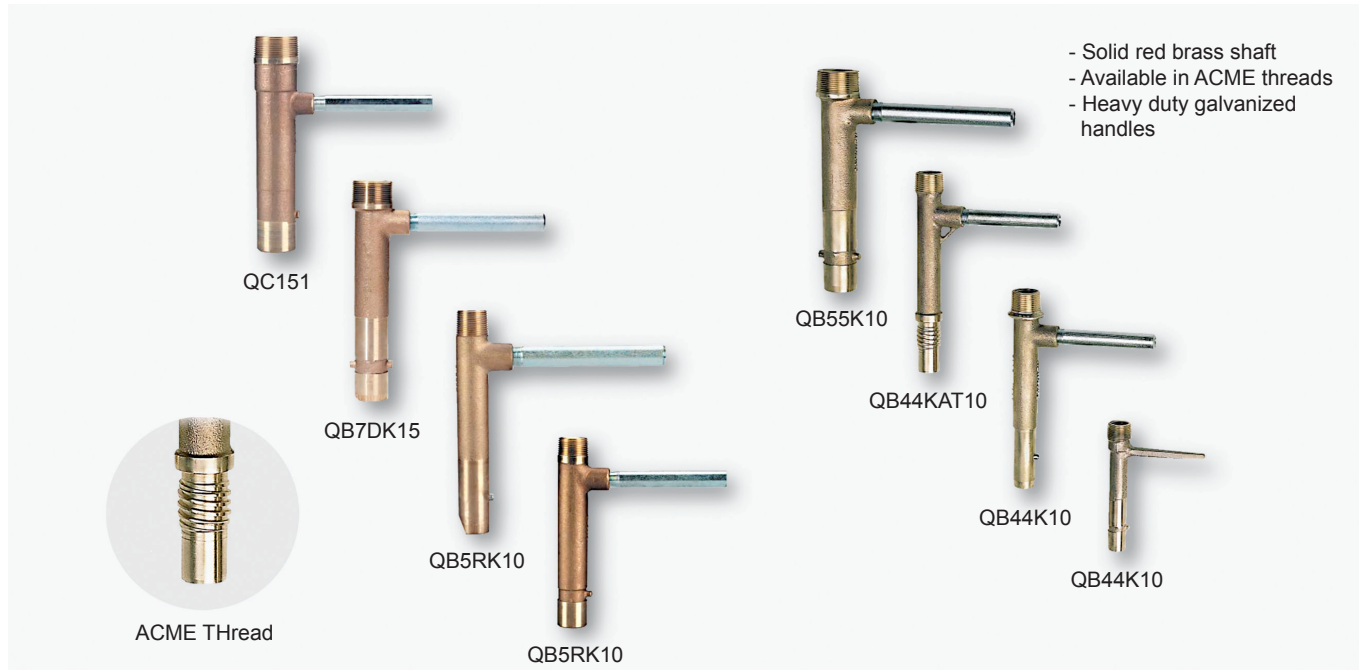

HS075
3/4" MHT x 3/4" FPT



HS100
3/4" MHT x 1" FPT



HS101
1" MHT x 1" FPT



HS125
1" MHT x 1 1/4" FPT



HS151
1" MHT x 1 1/2" FPT



TLK
Key for lock top quick coupling valves & valve markers



7640BS
3/4" NPT Male x 1/2" Female, ACME Thread



7641BS
1" NPT Male x 3/4" Female, ACME Thread





CONTROLLERS



Controllers

Sterling Series Controllers

4, 8, 12, 18, 24, 30 & 36 Station Models

Features and Benefits

- Six independent programs that can run concurrently
- Up to 9 daily cycle starts per program; or, loop watering optional in all six programs for unlimited cycles
- No limit on the number of programs to which a station can be assigned (all six if desired)
- Station timing adjustable from 1 minute to 24 hours in 1 minute increments. Seconds/minutes time base optional in all six programs. An illuminated LED lets you know if a program is in the seconds/minute mode
- Automatic, semi-automatic, manual, and timed manual operation
- Programmable watering calendar. The watering calendar is factory set at 7 days, but can be changed to any length from 1 to 32 days
- Programmable “system check” cycle that can be initiated at any station. Station “On” duration programmable from 1 min. to 15 min. (or 1 to 15 sec. per station)
- Water budgeting feature to simultaneously change the watering duration of all stations within a program (1% to 255%). An illuminated LED lets you know if water budgeting is set at other than 100%
- Single program option gives you the flexibility of having two or more programs scheduled, but limiting automatic operation to only that program at which the dial is set
- Programmable rain off up to 14 days. The controller will resume automatic operation on the day following the last “Off” day.
- Program erase feature allows existing programs to be erased individually or all at once
- Programmable pause of 1 second to 59 seconds between stations to allow full valve closure before advancing to the next station
- Programmable loop allows a program’s watering cycle to continuously repeat for a desired period
- Cycles can repeat immediately or after a programmed delay of 1 minute to 4 hours, 15 minutes
- Program 6 can be activated by a sensor switch such as a thermostat. Ideal for frost protection or cooling
- Simplified program review
- Program information can be scrolled on the display
- Master valve/pump start circuit can be disabled during operation of any program
- Master valve/pump start station can be turned on manually without another station turning on

Technical Information & Specifications

- Non-volatile memory holds program information during power outages of any length
- Ten year lithium battery (included) keeps real-time during power outages of any length
- Electronic circuit breaker identifies and overrides shorted solenoid valves
- Master valve/pump start circuit
- Wall or pedestal mount. Pedestal sold separately
- Weather-proof metal cabinet with lock and key



Electrical Specifications

Input: 120 VAC @ 50 or 60 Hz
Output: 24 VAC @ 50 VA

Maximum of two 4-watt solenoids per station.

Maximum of five 4-watt solenoids to operate simultaneously, or, for solenoids with current draw below 0.25 Amps, up to six solenoids can operate simultaneously.

Pedestal Specifications

- Heavy duty steel, rust resistant
- Weather proof
- Removable cover with lock and key
- Partition to separate valve wires from power supply wires



Controllers



Sterling Controller & Pedestal

Misting Applications

The Sterling is a highly flexible misting controller in addition to being ideally suited for virtually all other watering applications. An extra set of instructions tailored specifically for misting applications is included with controllers.

Misting Features & Benefits

- The time base in all six programs can be changed to seconds/minutes so that the individual station timing is adjustable from 1 second to 24 minutes in 1 second increments
- Misting cycles can repeat immediately or after a programmed delay of 1 minute to 4 hours, 15 minutes cycling can be started and stopped manually as well as automatically
- Stations can be assigned to multiple programs (up to six) with different "On" and "Off" durations in each program. This makes it possible for the "On" duration and "Off" duration of a station to change automatically during the day to match the changing misting requirements of plant material
- Programmable pause of 1 second to 59 seconds between stations to allow full valve closure before advancing to the next station

Terminal Strip Option (TS)

Sterling 18, 24, 30 and 36 models ordered with this option are equipped with terminal strips mounted to the inside rear of the enclosure to connect field wires.

Sensor Activation of Program #6

A temperature switch (or other "normally open" sensor switch) can be connected to sensor terminals of controller. When sensor contacts close, a watering cycle is initiated in program #6. The cycle will continuously repeat as long as the sensor switch remains closed.

If the Frost Override Option (one of 16 programmable options) is used, programs 1 through 5 will be suspended during the sensor activated operation of program #6. When the sensor switch opens, the watering cycle in program #6 will immediately stop and programs 1 through 5 will be allowed to resume operation.

Dimensions

Sterling 4, 8, & 12 with Pedestal

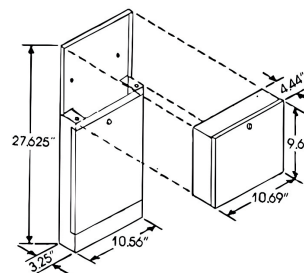

Sterling 18, 24, 30, & 12 with Pedestal

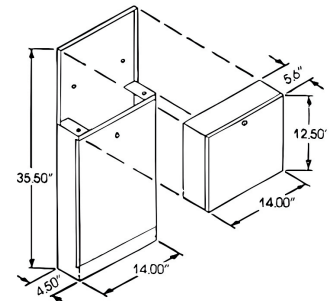



IMPACT SPRINKLERS



1/2" Full Circle Brass Impact Sprinkler

17023R

Designed for agricultural use in center pivots, solid sets, hand lines, crop cooling and frost control, these models of impact sprinklers can also be used in landscape irrigation situations requiring large area coverage.

Features and Benefits

- Solid brass construction
- Stainless steel springs, spindle and fulcrum pin
- "Sure Seal®" sand load bearing assembly
- Chemical-resistant bearing seals promote longer lifespan
- 23° angle of trajectory
- Parts interchangeable with Rainbird 20JH

Operating Ranges

Pressure: 25 to 60 PSI
 Flow: 1.28 to 5.48 GPM
 Spacing: 33 to 44 ft
 Trajectory: 23°
 Rotation: Full Circle

Specifications

- Inlet: 1/2" MNPT
- Nozzle: 3/8" - 24 UNF

To Specify

17023R	06
Model	Nozzle

Nozzle Code

Code	Inches	mm
06	3/32"	2.40
07	7/64"	2.80
08	1/8"	3.20
09	9/64"	3.60
10	5/32"	4.00

Standard Nozzle Performance

Nozzle Sizes

PSI	7/64"		3/32"		1/8"		9/64"		5/32"	
	Dia	GPM	Dia	GPM	Dia	GPM	Dia	GPM	Dia	GPM
35	76	2.05	68	1.49	78	2.67	82	3.40	84	4.19
40	78	2.20	70	1.6	80	2.86	82	3.62	84	4.48
45	78	2.33	70	1.72	80	3.04	84	3.84	84	4.72
50	80	2.45	72	1.81	82	3.21	84	4.07	86	4.99
55	80	2.56	72	1.9	82	3.35	86	4.23	86	5.22
60	80	2.69	74	1.98	82	3.51	86	4.42	88	5.48

Diameters in feet
 Nominal stream height 7'



1/2" Full Circle Brass Impact Sprinkler

17023W

Designed for agricultural use in solid sets, hand lines, center pivot, crop cooling and frost control. Can also be used in landscape irrigation situations requiring large area coverage.

Features and Benefits

- Solid brass construction
- Stainless steel springs, spindle and fulcrum pin
- "Sure Seal®" sand load bearing assembly
- Bearing assembly hood designed to ensure longevity
- Chemical-resistant bearing seals promote longer lifespan
- 23° angle of trajectory
- Parts interchangeable with WeatherTec 10-20

Operating Ranges

Pressure: 25 to 60 PSI
 Flow: 1.28 to 5.48 GPM
 Spacing: 33 to 44 ft
 Trajectory: 23°
 Rotation: Full Circle

Specifications

- Inlet: 1/2" MNPT
- Nozzle Thread: 1/8" - 27 NPT

To Specify

17023W	05
Model	Nozzle

Nozzle Code

Code	Inches	mm
06	3/32"	2.40
07	7/64"	2.80
08	1/8"	3.20
09	9/64"	3.60
10	5/32"	4.00

Standard Nozzle Performance

Nozzle Sizes

PSI	3/32"		#39		7/64"		1/8"		9/64"	
	Dia	GPM	Dia	GPM	Dia	GPM	Dia	GPM	Dia	GPM
25	67	1.28	68	1.44	69	1.73	71	2.19	74	2.82
30	69	1.41	70	1.59	71	1.89	74	2.42	77	3.10
35	70	1.51	71	1.68	73	2.04	76	2.60	79	3.36
40	71	1.62	72	1.80	74	2.19	77	2.79	80	3.61
45	72	1.72	73	1.92	75	2.31	78	2.96	81	3.81
50	73	1.84	74	2.02	76	2.44	79	3.14	82	4.03
55	74	1.92	75	2.10	77	2.57	80	3.27	83	4.23
60	75	2.02	76	2.19	78	2.67	81	3.44	84	4.44

Diameters in feet
 Nominal stream height 7'



1/2" Wedge Brass Impact Sprinkler

170W23R

Designed for agricultural use in solid sets, hand lines, center pivot, crop cooling and frost control where smaller nozzles are required. Can also be used in landscape irrigation situations requiring large area coverage.

Features and Benefits

- Solid brass construction
- Stainless steel springs, spindle and fulcrum pin
- "Sure Seal®" sand load bearing assembly
- Plastic, self-cleaning wedge drive assembly
- Chemical-resistant bearing seals promote longer lifespan
- 23° angle of trajectory
- Parts interchangeable with Rainbird 14VH

Operating Ranges

Pressure: 25 to 60 PSI
 Flow: 0.33 to 3.51 GPM
 Spacing: 31 to 41 ft
 Trajectory: 23°
 Rotation: Full Circle



Specifications

- Inlet: 1/2" MNPT
- Nozzle Thread: 3/8" - 24 UNF

How to Specify

17023R	05
Model	Nozzle

Nozzle Code

Code	Inches	mm
04	1/16"	1.60
05	5/64"	2.00
06	3/32"	2.40
07	7/64"	2.80

Standard Nozzle Performance

Nozzle Sizes

PSI	1/16"		#51		#50		5/64"		#44		3/32"		7/64"	
	Dia	GPM	Dia	GPM	Dia	GPM	Dia	GPM	Dia	GPM	Dia	GPM	Dia	GPM
25	58	0.56	58	0.64	60	0.69	62	0.89	64	1.06	66	1.26	70	1.72
30	58	0.63	60	0.7	60	0.77	62	0.98	66	1.16	68	1.38	70	1.91
35	60	0.67	60	0.78	62	0.83	64	1.04	66	1.28	68	1.49	72	2.04
40	60	0.72	62	0.84	62	0.91	64	1.11	68	1.37	70	1.60	74	2.20
45	62	0.76	62	0.88	64	0.96	66	1.18	68	1.45	70	1.72	74	2.33
50	62	0.80	64	0.91	64	1.01	68	1.26	70	1.50	72	1.81	76	2.46
55	64	0.83	64	0.97	66	1.04	68	1.30	70	1.56	72	1.90	76	2.56
60	64	0.87	66	1.01	66	1.11	68	1.36	72	1.61	74	1.98	76	2.67

Diameters in feet



1/2" Wedge Brass Impact Sprinkler

170W23W

Designed for agricultural use in solid sets, hand lines, center pivot, crop cooling and frost control where smaller nozzles are required. Can also be used in landscape irrigation situations requiring large area coverage.

Features and Benefits

- Solid brass construction
- Stainless steel springs, spindle and fulcrum pin
- "Sure Seal®" sand load bearing assembly
- Plastic, self-cleaning wedge drive assembly
- Bearing assembly hood designed to ensure longevity
- Chemical-resistant bearing seals promote longer lifespan
- 23° angle of trajectory

Operating Ranges

Pressure: 25 to 60 PSI
 Flow: 0.33 to 3.51 GPM
 Spacing: 31 to 41 ft
 Trajectory: 23°
 Rotation: Full Circle



Specifications

- Inlet: 1/2" MNPT
- Nozzle Thread: 1/8" - 27 NPT

How to Specify

170W23W	05
Model	Nozzle

Nozzle Code

Code	Inches	mm
04	1/16"	1.60
05	5/64"	2.00
06	3/32"	2.40
07	7/64"	2.80

Standard Nozzle Performance

Nozzle Sizes

PSI	#55		1/16"		5/64"		3/32"		7/64"		1/8"	
	Dia	GPM	Dia	GPM	Dia	GPM	Dia	GPM	Dia	GPM	Dia	GPM
25	62	0.33	66	0.54	62	0.85	64	1.28	74	1.70	72	2.25
30	65	0.38	68	0.61	64	0.92	68	1.40	75	1.83	76	2.46
35	68	0.44	70	0.66	66	1.01	72	1.53	76	2.03	78	2.68
40	66	0.47	69	0.71	65	1.08	72	1.65	76	2.19	78	2.81
45	64	0.51	68	0.77	64	1.15	72	1.75	76	2.32	78	3.02
50	64	0.55	67	0.83	64	1.22	73	1.82	77	2.45	80	3.20
55	64	0.57	66	0.86	64	1.29	74	1.95	78	2.57	82	3.36
60	61	0.61	65	0.89	65	1.36	74	2.03	78	2.70	82	3.51

Diameters in feet



1/2" Wedge Brass Impact Sprinklers

170W15RP

Designed for agricultural use in under tree solid sets where trajectory is limited due to foliage. Also used for crop cooling and frost control.

Features and Benefits

- Solid brass construction
- Stainless steel springs and fulcrum pin
- Plastic, self-cleaning wedge drive assembly
- "Sure Seal®" sand load bearing assembly
- Chemical-resistant bearing seals promote longer lifespan
- Plastic bearing for PVC riser applications
- 15° angle of trajectory

Operating Ranges

Pressure: 25 to 50 PSI
 Flow: 0.55 to 2.45 GPM
 Spacing: 25 to 35 ft
 Trajectory: 15°
 Rotation: Full Circle

Specifications

- 1/2" NPT inlet plastic bearing
- 170W15RP nozzle thread, 3/8" - 24 UNF

How To Specify

170W15RP	05
Model	Nozzle

Nozzle Code

Code	Inches	mm
04	1/16"	1.60
05	5/64"	2.00
06	3/32"	2.40
07	7/64"	2.80
#51	0.067"	1.70
#50	0.07"	1.77
#44	0.086"	2.18

Standard Nozzle Performance

Nozzle Sizes

PSI	1/18"		#51		#50		5/64"		#44		3/32"		7/64"	
	Dia	GPM	Dia	GPM	Dia	GPM	Dia	GPM	Dia	GPM	Dia	GPM	Dia	GPM
25	51	0.56	52	0.65	53	0.70	54	0.88	55	1.07	57	1.27	61	1.73
30	53	0.62	54	0.71	55	0.78	56	0.97	57	1.17	59	1.39	63	1.90
35	54	0.66	56	0.77	57	0.84	58	1.05	60	1.27	61	1.50	65	2.05
40	56	0.72	57	0.83	58	0.90	60	1.12	62	1.36	63	1.61	67	2.19
45	57	0.75	59	0.87	60	0.95	62	1.19	63	1.44	65	1.71	69	2.32
50	58	0.80	60	0.92	61	1.00	63	1.25	64	1.51	66	1.80	70	2.45

Diameters in feet



3/4" Full Circle Brass Impact Sprinklers

2000S

Designed for agricultural use in solid sets, hand lines, center pivots, wheel lines, side rolls, crop cooling, frost control, and landscape irrigation situations requiring large area coverage. The 2000 series can also be used in the mining and logging industries.

Features and Benefits

- Solid brass construction
- Stainless steel springs and fulcrum pin
- "Sure Seal®" sand load bearing assembly
- Bearing assembly hood designed to ensure longevity
- Chemical-resistant bearing seals promote longer lifespan
- Dual or single nozzle
- Stream straightening vane optional (specify 2000SX)
- 25° angle of trajectory

Operating Ranges

Pressure: 30 to 80 PSI
 Flow: 2.53 to 15.71 GPM
 Spacing: 40 to 60 ft
 Trajectory: 25°
 Rotation: Full Circle

Specifications

- 3/4" male inlet, National Pipe Thread (NPT)
- Drive side nozzle 1/4" - 18 NPT
- Range side nozzle 3/8" - 24 UNF

How to Specify

2000S	08	PG
Model	Drive Nozzle	Range Nozzle

Nozzle Code

Code	Inches	mm
06	3/32"	2.40
08	1/8"	3.20
09	9/64"	3.60
10	5/32"	4.00
11	11/64"	4.30
12	3/16"	4.80
13	13/64"	5.20
14	7/32"	5.60
PG	Plug Nozzle	



3/4" Full Circle Brass Impact Sprinklers

2000S Standard Single Nozzle Performance

Single Nozzle	Pressure PSI	Radius Feet	Flow GPM
08	35	80	2.69
	40	82	2.88
	45	82	3.05
	50	83	3.21
	55	84	3.37
	60	85	3.53
	65	85	3.67
	70	85	3.81
09	75	85	3.94
	80	85	4.07
	35	82	3.47
	40	83	3.74
	45	84	4.01
	50	85	4.13
	55	86	4.18
	60	87	4.28
10	65	88	4.49
	70	89	4.69
	75	90	4.83
	80	91	4.96
	35	87	4.35
	40	88	4.62
	45	89	4.90
	50	90	5.17
11	55	91	5.44
	60	92	5.64
	65	93	5.92
	70	94	6.05
	75	95	6.26
	80	96	6.53
	35	90	5.03
	40	92	5.57
12	45	94	5.64
	50	95	6.05
	55	96	6.39
	60	97	6.53
	65	98	6.87
	70	99	7.21
	75	100	7.41
	80	101	7.62
13	35	95	5.84
	40	97	6.32
	45	98	6.66
	50	100	7.01
	55	101	7.34
	60	102	7.68
	65	103	7.95
	70	104	8.29
14	75	105	8.56
	80	106	8.84
	35	97	7.21
	40	100	7.68
	45	102	8.23
	50	103	8.70
	55	104	9.04
	60	105	9.38
14	65	106	9.79
	70	107	10.13
	75	108	10.47
	80	109	10.74
	35	100	7.75
	40	103	8.29
	45	105	8.77
	50	106	9.31
14	55	107	9.65
	60	108	10.21
	65	109	10.61
	70	110	10.94
	75	111	11.28
	80	112	11.69

2000S Standard Dual Nozzle Performance

Dual Nozzle	Pressure PSI	Radius Feet	Flow GPM
09 / 06	35	41	4.89
	40	42	5.24
	45	42	5.71
	50	43	5.85
	55	43	6.19
	60	44	6.39
	65	44	6.73
	70	45	6.94
10 / 06	75	45	7.14
	80	46	7.28
	35	44	5.78
	40	44	6.26
	45	45	6.66
	50	45	6.87
	55	46	7.21
	60	46	7.55
11 / 06	65	47	7.88
	70	47	8.16
	75	48	8.36
	80	48	8.64
	35	45	6.73
	40	46	7.21
	45	47	7.62
	50	48	8.03
12 / 06	55	48	8.43
	60	49	8.71
	65	49	9.11
	70	50	9.45
	75	50	9.79
	80	51	10.06
	35	48	7.41
	40	49	7.82
12 / 08	45	49	8.29
	50	50	8.77
	55	51	9.18
	60	51	9.58
	65	52	9.86
	70	52	10.26
	75	53	10.67
	80	53	10.94
13 / 08	35	48	8.63
	40	49	9.31
	45	49	9.79
	50	50	10.41
	55	51	10.88
	60	51	11.28
	65	52	11.76
	70	52	12.17
14 / 08	75	53	12.58
	80	53	13.05
	35	49	9.66
	40	50	10.27
	45	51	10.88
	50	52	11.42
	55	52	12.04
	60	53	12.58
14 / 08	65	53	13.06
	70	54	13.43
	75	54	13.82
	80	55	14.21
	35	50	10.61
	40	52	11.28
	45	53	11.91
	50	53	12.58
14 / 08	55	54	13.12
	60	54	13.73
	65	55	14.21
	70	55	14.75
	75	56	15.23
	80	56	15.71



1" Full Circle Brass Impact Sprinklers

300SAX

Designed for agricultural use in solid sets, hand lines, side rolls, hose reels and landscape irrigation situations requiring large area coverage. The 300 series can also be used in the mining, logging and waste water treatment industries.

Features & Benefits

- Solid brass construction
- Stainless steel springs and fulcrum pin
- "Sure Seal®" sand load bearing assembly
- Bearing assembly hood designed to ensure longevity
- Chemical-resistant bearing seals promote longer lifespan
- Adjustable diffuser pin
- Stream straightening vane standard
- 23° angle of trajectory
- Dual opposing nozzles

Operating Ranges

Pressure: 40 to 80 PSI
 Flow: 14.61 to 46.59 GPM
 Throw: 47 to 80 ft radius
 Trajectory: 23°
 Rotation: Full Circle

Specifications

- Inlet: 1" MNPT
- Drive Nozzle Thread: 1/4" - 18 NPT
- Range Nozzle Thread: 5/8" - 18 UNF

How to Specify

300SAX	12	14
Model	Drive Nozzle	Range Nozzle

Nozzle Code

Code	Inches	mm
08	1/8"	3.20
12	3/16"	4.80
14	7/32"	5.60
16	1/4"	6.40
18	9/32"	7.10
20	5/16"	7.90
22	11/32"	8.30
24	3/8"	8.50



1" Full Circle Brass Impact Sprinklers

300SAX Standard Dual Nozzle Performance

Dual Nozzle	Pressure PSI	Radius Feet	Flow GPM
12 / 14 (3/16" x 7/32")	40	59	14.61
	45	60	15.43
	50	61	16.32
	55	62	16.99
	60	63	17.89
	65	64	18.56
	70	65	19.23
	75	66	19.84
	80	67	20.53
	85	68	21.24
	90	67	20.53
95	71	22.66	
100	73	23.37	
12 / 16 (3/16" x 1/4")	40	61	17.02
	45	62	17.88
	50	63	18.91
	55	64	19.85
	60	64	19.85
	65	65	21.48
	70	68	23.12
	75	68	23.12
	80	69	24.07
	85	70	24.91
	90	72	25.75
95	73	26.59	
100	75	27.43	
14 / 16 (7/32" x 1/4")	40	62	18.56
	45	63	19.65
	50	63	20.74
	55	64	21.76
	60	64	22.91
	65	65	23.66
	70	66	24.61
	75	67	25.43
	80	68	26.24
	85	70	28.73
	90	72	31.22
95	74	32.07	
100	76	32.91	
14 / 18 (7/32" x 9/32")	40	63	20.94
	45	64	22.23
	50	65	23.39
	55	66	24.54
	60	68	25.56
	65	69	26.58
	70	71	27.64
	75	72	28.49
	80	73	29.44
	85	73	32.68
	90	75	35.92
95	76	36.89	
100	78	37.86	

300SAX Standard Dual Nozzle Performance

Dual Nozzle	Pressure PSI	Radius Feet	Flow GPM
14 / 20 (7/32" x 5/16")	40	64	23.46
	45	66	25.03
	50	67	26.25
	55	68	27.61
	60	69	28.70
	65	71	29.92
	70	72	30.87
	75	73	32.03
	80	74	32.91
	85	76	37.04
	90	78	41.17
95	79	42.28	
100	81	43.39	
16 / 22 (1/4" x 11/32")	40	65	30.05
	45	67	31.81
	50	68	33.52
	55	70	35.22
	60	73	36.78
	65	74	37.8
	70	75	39.56
	75	76	40.93
	80	78	42.30
	85	77	46.71
	90	79	51.11
95	81	52.50	
100	83	53.88	
16 / 24 (1/4" x 3/8")	40	66	34.06
	45	67	36.16
	50	70	38.21
	55	72	40.06
	60	75	41.67
	65	77	43.38
	70	78	44.87
	75	79	46.64
	80	80	48.08
	85	82	52.77
	90	84	57.46
95	85	59.02	
100	87	60.57	



1" Full Circle Brass Impact Sprinkler

350SAX

Designed for agricultural use in solid sets, hand lines, side rolls, hose reels and landscape irrigation situations requiring large area coverage. The 350 series can also be used in the mining, logging and waste water treatment industries.

Features & Benefits

- Solid brass construction
- Stainless steel springs and fulcrum pin
- "Sure Seal®" sand load bearing assembly
- Chemical-resistant bearing seals promote longer lifespan
- Adjustable diffuser pin
- Over-under nozzles
- Dual or single nozzle
- Stream straightening vane standard
- 23° angle of trajectory

Operating Ranges

Pressure: 40 to 80 PSI
 Flow: 14.6 to 46.6 GPM
 Throw: 47 to 80 ft radius
 Trajectory: 23°
 Rotation: Full Circle

Specifications

- Inlet: 1" MNPT
- Drive Nozzle Thread: 5/8" - 18 UNF
- Filler Nozzle Thread: 3/8" - 24 UNF

How to Specify

350SAX	12	PG
Model	Drive Nozzle	Filler Nozzle

Nozzle Code

Code	Inches	mm
08	1/8"	3.20
12	3/16"	4.80
14	7/32"	5.60
16	1/4"	6.40
18	9/32"	7.10
20	5/16"	7.90
22	11/32"	8.30
24	3/8"	8.50
PG	Plug	



1" Full Circle Brass Impact Sprinklers

350SAX Standard Single Nozzle Performance

Single Nozzle	Pressure PSI	Radius Feet	Flow GPM	Single Nozzle	Pressure PSI	Radius Feet	Flow GPM
12 / PG (3/16")	40	49	6.32	24 / PG (3/8")	40	63	23.12
	45	50	6.66		45	65	24.54
	50	51	7.01		50	67	25.97
	55	52	7.34		55	70	27.21
	60	52	7.68		60	73	28.35
	65	53	7.95		65	75	29.51
	70	53	8.29		70	76	30.53
	75	54	8.56		75	76	31.82
	80	55	8.84		80	78	32.77
	85	57	9.40		85	79	36.28
90	58	9.95	90	80	39.78		
95	60	10.22	95	82	40.86		
100	61	10.48	100	84	41.93		
14 / PG (3/16")	40	51	8.29				
	45	53	8.77				
	50	55	9.31				
	55	57	9.65				
	60	58	10.21				
	65	60	10.61				
	70	61	10.94				
	75	62	11.28				
	80	63	11.69				
	85	65	12.62				
90	66	13.54					
95	68	13.91					
100	70	14.27					
16 / PG (1/4")	40	54	10.94				
	45	55	11.62				
	50	58	12.24				
	55	59	12.85				
	60	60	13.32				
	65	62	13.87				
	70	63	14.34				
	75	64	14.82				
	80	65	15.31				
	85	66	16.50				
90	68	17.68					
95	70	18.16					
100	71	18.64					
18 / PG (9/32")	40	58	13.94				
	45	60	14.75				
	50	62	15.43				
	55	63	16.32				
	60	65	17.01				
	65	67	17.61				
	70	69	18.29				
	75	70	18.91				
	80	71	19.52				
	85	72	20.95				
90	74	22.38					
95	75	22.99					
100	76	23.59					
20 / PG (5/16")	40	60	16.72				
	45	62	17.61				
	50	63	18.63				
	55	65	19.44				
	60	67	20.33				
	65	69	21.14				
	70	67	21.96				
	75	73	22.71				
	80	74	23.46				
	85	75	25.55				
90	77	27.63					
95	78	29.87					
100	80	29.12					
22 / PG (11/32")	40	61	19.11				
	45	63	20.19				
	50	65	21.28				
	55	67	22.37				
	60	69	23.46				
	65	71	24.01				
	70	73	25.22				
	75	74	26.11				
	80	76	26.99				
	85	77	30.21				
90	79	33.43					
95	80	34.34					
100	82	35.24					

350SAX Standard Dual Nozzle Performance

Dual Nozzle	Pressure PSI	Flow GPM	Dual Nozzle	Pressure PSI	Flow GPM
12 / 08 (3/16" x 1/8")	40	9.31	24 / 08 (3/8" x 1/8")	40	25.22
	45	9.79		45	26.72
	50	10.41		50	28.83
	55	10.88		55	29.65
	60	11.28		60	30.80
	65	11.76		65	31.96
	70	12.17		70	35.05
	75	12.58		75	34.07
	80	13.05		80	35.36
	85	13.71		85	39.78
90	14.37	90	44.20		
95	14.76	95	45.40		
100	15.14	100	46.59		
14 / 08 (3/16" x 1/8")	40	11.28			
	45	11.91			
	50	12.58			
	55	13.12			
	60	13.73			
	65	14.21			
	70	14.75			
	75	15.23			
	80	15.71			
	85	16.84			
90	17.96				
95	18.45				
100	18.93				
16 / 08 (1/4" x 1/8")	40	14.07			
	45	14.89			
	50	15.84			
	55	16.52			
	60	17.06			
	65	17.88			
	70	18.56			
	75	19.04			
	80	19.72			
	85	20.91			
90	22.10				
95	22.70				
100	23.30				
18 / 08 (9/32" x 1/8")	40	16.52			
	45	17.54			
	50	18.49			
	55	19.31			
	60	20.26			
	65	21.01			
	70	21.82			
	75	22.57			
	80	23.25			
	85	25.03			
90	26.80				
95	27.53				
100	28.25				
20 / 08 (5/16" x 1/8")	40	19.38			
	45	20.40			
	50	21.35			
	55	22.51			
	60	23.52			
	65	24.41			
	70	25.36			
	75	26.18			
	80	26.99			
	85	29.52			
90	32.05				
95	32.92				
100	33.78				
22 / 08 (11/32" x 1/8")	40	21.49			
	45	23.05			
	50	24.28			
	55	25.56			
	60	26.52			
	65	27.54			
	70	28.70			
	75	29.37			
	80	30.32			
	85	34.09			
90	37.85				
95	38.88				
100	39.90				



1 1/4" Full Circle Brass Impact Sprinkler



400S

Designed for large volume coverage over a wide area. Ideal for pasture and commercial applications including fertilizer disbursement, waste water treatment, water reclamation, mining, logging and dust control.

Features & Benefits

- Solid brass construction
- Stainless steel springs and fulcrum pin
- "Sure Seal®" sand load bearing assembly
- Chemical-resistant bearing seals promote longer lifespan
- Adjustable diffuser pin
- Opposing nozzles
- Range tube to increase radius
- 23° angle of trajectory

Nozzle Code

Code	Inches	mm
14	7/32"	5.6
16	1/4"	6.4
22	11/32"	8.7
24	3/8"	9.5
26	13/32"	10.3
28	7/16"	11.1
30	15/32"	11.9
32	1/2"	12.7
34	17/32"	13.5
36	9/16"	14.3
40	5/8"	15.90

Operating Ranges

Pressure: 65 to 100 PSI
 Flow: 34.62 to 132.18 GPM
 Throw: 85 to 117 ft radius
 Trajectory: 23°
 Rotation: Full Circle

Specifications

- 1 1/4" male inlet, National Pipe Thread (NPT)
- Drive nozzle 3/4" – 16 UNF
- Range nozzle 3/4" – 16 UNF

How to Specify

400S	14	22
Model	Drive Nozzle	Range Nozzle



1 1/4" Full Circle Brass Impact Sprinkler

400S Standard Dual Nozzle Performance

Dual Nozzle	Pressure PSI	Radius Feet	Flow GPM
14 / 22	65	86	34.62
	70	87	36.16
	75	89	37.39
	80	90	38.68
	85	92	39.85
	90	93	41.00
	95	94	42.08
14 / 24	100	95	42.97
	65	89	40.12
	70	90	41.47
	75	92	43.10
	80	93	44.46
	85	95	45.70
	90	96	46.99
14 / 26	95	97	48.20
	100	98	49.56
	65	91	46.50
	70	93	48.68
	75	94	50.13
	80	96	51.65
	85	97	53.55
16 / 28	90	99	54.86
	95	100	56.37
	100	101	58.00
	65	94	56.05
	70	95	58.18
	75	97	59.96
	80	98	61.93
16 / 30	85	100	63.86
	90	101	65.57
	95	102	67.65
	100	103	69.30
	65	96	62.52
	70	98	65.03
	75	99	67.17
16 / 32	80	101	69.52
	85	102	71.45
	90	104	73.34
	95	105	75.42
	100	106	77.25
	65	99	68.81
	70	100	71.69
16 / 34	75	102	74.20
	80	103	75.43
	85	105	79.04
	90	106	81.11
	95	107	83.23
	100	108	85.21
	65	101	80.28
16 / 36	70	103	82.97
	75	104	84.56
	80	106	87.46
	85	107	89.95
	90	109	92.79
	95	110	95.63
	100	111	98.60

400S Standard Dual Nozzle Performance

Dual Nozzle	Pressure PSI	Radius Feet	Flow GPM
16 / 36	65	104	80.28
	70	105	82.97
	75	107	84.56
	80	108	87.46
	85	110	89.95
	90	111	92.79
	95	112	95.63
16 / 40	100	113	85.21
	65	108	97.42
	70	110	102.39
	75	111	107.37
	80	113	112.36
	85	114	117.32
	90	116	122.23
16 / 40	95	117	127.14
	100	118	132.18



1 1/4" Full Circle Brass Impact Sprinklers

AI120

Designed for large area commercial, agricultural, municipal or pasture applications. Provides long range and uniform water distribution required in fertilizer disbursement, mining, logging and dust control. Also ideal for large turf applications.

Features and Benefits

- Solid brass construction
- Stainless steel springs and fulcrum pin
- "Sure Seal®" sand load bearing assembly
- Chemical-resistant bearing seals promote longer lifespan
- Over-under nozzles
- Dual or single nozzle
- Stream straightening vane standard
- 23° angle of trajectory

Operating Ranges

Pressure: 55 to 95 PSI
 Flow: 24.9 to 121 GPM
 Throw: 75 to 113 ft radius
 Rotation: Full Circle

Specifications

- 1 1/4" male inlet, National Pipe Thread (NPT)
- Drive nozzle 1" – 20 UNF
- Filler nozzle 1/8" – 27 NPT

How to Specify

AI120	24	14
Model	Drive Nozzle	Filler Nozzle

Nozzle Code

Code	Inches	mm
PG	Plug	
14	7/32"	5.60
15	15/64"	6.00
16	1/4"	6.40
17	17/64"	6.70
18	9/32"	7.10
22	11/32"	8.70
24	3/8"	9.50
26	13/32"	10.30
28	7/16"	11.10
32	1/2"	12.70
34	17/32"	13.50
36	9/16"	14.30
40	5/8"	15.90



1 1/4" Full Circle Brass Impact Sprinklers

AI120 Performance

23° Trajectory

Nozzle Code	Pressure PSI	Radius Feet	Flow GPM
22 / PG	55	73	24.9
	60	75	25.8
	65	77	26.9
	70	80	27.0
	75	81	28.9
	80	81	30.4
	85	81	31.1
	90	83	32.7
24 / PG	95	85	32.8
	55	75	29.6
	60	79	30.8
	65	81	32.0
	70	83	33.3
	75	85	34.7
	80	86	35.7
	85	87	36.0
26 / PG	90	89	38.3
	95	91	39.1
	55	75	32.9
	60	76	34.4
	65	77	35.8
	70	77	37.2
	75	77	38.5
	80	78	39.9
28 / PG	85	79	41.2
	90	79	42.3
	95	79	43.3
	55	83	39.7
	60	86	41.6
	65	87	43.3
	70	89	45.1
	75	90	46.8
32 / PG	80	91	48.0
	85	93	50.0
	90	95	51.5
	95	96	53.0
	55	89	50.7
	60	91	53.0
	65	93	55.3
	70	94	57.7
36 / PG	75	96	59.6
	80	101	63.0
	85	102	63.5
	90	103	65.3
	95	105	67.1
	55	96	63.2
	60	97	65.5
	65	99	69.4
40 / PG	70	101	72.2
	75	102	74.9
	80	104	77.5
	85	105	80.0
	90	106	82.2
	95	108	84.3
	55	97	84.9
	60	101	89.0
40 / PG	65	105	93.2
	70	107	96.5
	75	109	99.8
	80	110	102.9
	85	111	106.0
	90	112	109.3
	95	113	112.0

AI120 Performance

23° Trajectory

Nozzle Code	Pressure PSI	Radius Feet	Flow GPM
22 / 14	55	73	34.9
	60	75	36.5
	65	77	38.0
	70	80	38.8
	75	81	41.0
	80	81	42.6
	85	81	43.8
	90	83	44.0
24 / 14	95	85	45.6
	55	77	35.7
	60	79	37.2
	65	81	38.7
	70	83	40.2
	75	85	41.7
	80	85	43.2
	85	86	44.7
26 / 14	90	87	46.2
	95	87	46.9
	55	75	43.4
	60	76	46.6
	65	77	48.6
	70	77	50.4
	75	77	52.4
	80	78	54.3
28 / 14	85	79	56.0
	90	79	57.9
	95	79	59.6
	55	83	49.1
	60	86	51.5
	65	87	53.8
	70	89	55.9
	75	90	57.9
32 / 16	80	91	60.0
	85	93	62.0
	90	95	63.9
	95	96	65.8
	55	89	63.9
	60	91	67.0
	65	93	70.0
	70	94	72.6
36 / 16	75	96	75.4
	80	101	75.6
	85	102	80.5
	90	103	83.6
	95	105	85.0
	55	96	76.8
	60	97	80.5
	65	99	84.1
40 / 16	70	101	87.4
	75	102	90.7
	80	104	93.6
	85	105	96.9
	90	106	99.5
	95	108	102.0
	55	97	90.0
	60	101	94.7
40 / 16	65	105	99.2
	70	107	103.0
	75	109	107.0
	80	110	110.0
	85	111	114.0
	90	112	117.0
	95	113	121.0



1/2" Full/Part Circle Brass Impact Sprinklers

90SD

Designed for use in general landscape irrigation, nurseries, greenhouses, and industrial applications.

Features and Benefits

- Solid brass construction
- Manganese bronze die cast arm
- Patented spray distribution grooves
- Stainless steel springs, trip assembly and fulcrum pin
- "Sure Seal®" sand load bearing assembly
- Anti-backsplash arm
- Adjustable deflector plate
- Chemical-resistant bearing seals promote longer lifespan
- Stream straightening vane standard
- 25° angle of trajectory

Operating Ranges

Pressure: 25 to 55 PSI
 Flow: 3.54 to 5.44 GPM
 Spacing: 35 to 48 ft
 Trajectory: 25°
 Rotation: 20° to 340° or Full Circle

Specifications

- 1/2" male inlet, National Pipe Thread (NPT)
- Drive nozzle 5/32" – 24 UNF

Model Description

Model No.	Description
90SD10	Impact, 1/2" Full/Part Circle, 5/32"

Standard Nozzle Performance

Nozzle	Pressure PSI	Radius feet	Flow GPM
10*	25	35	3.54
	30	39	3.94
	35	42	4.35
	40	43	4.62
	45	44	4.90
	50	47	5.17
	55	48	5.44

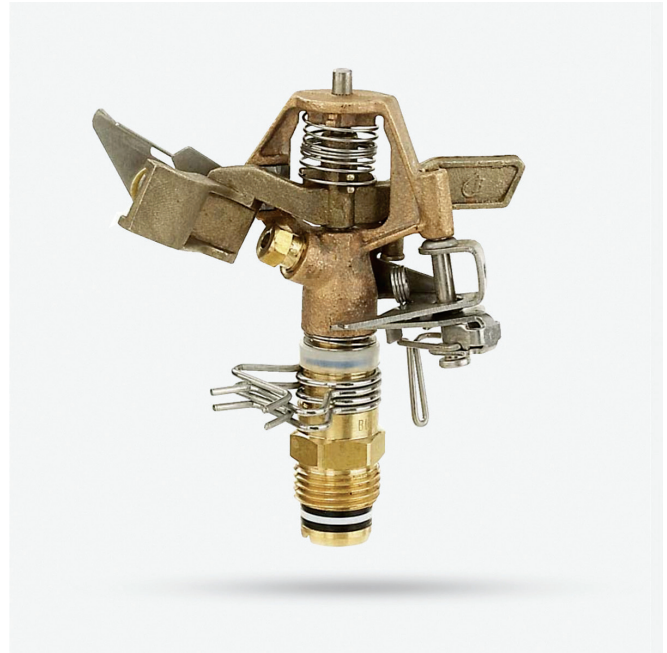

1/2" Full/Part Circle Plastic & Zinc Impact Sprinklers



65P

Ideal for budget projects including lawn and garden irrigation, nurseries, greenhouses, and temporary installations.

Features and Benefits

- Heavy duty plastic construction
- Stainless steel springs and fulcrum pin
- Adjustable deflector plate
- Adjustable diffuser pin
- Anti-backsplash arm
- Chemical-resistant bearing seals promote longer lifespan
- Stream straightening vane built into nozzle
- Bayonet nozzle
- 25° angle of trajectory

Operating Ranges

Pressure: 25 to 60 PSI
 Flow: 3.54 to 5.64 GPM
 Spacing: 33 to 47 ft
 Trajectory: 25°
 Rotation: 20° to 340° or Full Circle

Model Description

Model No.	Description
65P10	1/2" Full/Part circle, heavy duty plastic impact sprinkler

Standard Nozzle Performance Chart

Nozzle	Pressure PSI	Radius Feet	Flow GPM
10	25	34	3.54
	30	35	3.94
	35	38	4.35
	40	41	4.62
	45	43	4.90
	50	45	5.17
	55	46	5.44
	60	47	5.64



90DZ

Ideal for budget projects including lawn and garden irrigation, nurseries, greenhouses, and temporary installations.

Features and Benefits

- Powder coated zinc die cast construction
- Stainless steel springs and fulcrum pin
- Adjustable deflector plate
- Adjustable diffuser pin
- Anti-backsplash arm
- Chemical-resistant bearing seals promote longer lifespan
- Stream straightening vane included
- 25° angle of trajectory

Operating Ranges

Pressure: 25 to 55 PSI
 Flow: 2.11 to 5.64 GPM
 Spacing: 34 to 47 ft
 Trajectory: 25°
 Rotation: 20° to 340° or Full Circle

Model Description

Model No.	Description
90DZ10	1/2" Full/Part circle, powder coated zinc die-cast impact sprinkler

Standard Nozzle Performance Chart

Nozzle	Pressure PSI	Radius Feet	Flow GPM
10	25	34	3.54
	30	35	3.94
	35	38	4.35
	40	41	4.62
	45	43	4.90
	50	45	5.17
	55	46	5.44



3/4" Full/Part Circle Brass Impact Sprinklers

261SDX

Designed for use in large landscape/turf irrigation, dust control, nurseries and general purpose use.

Features and Benefits

- Solid brass construction
- Stainless steel springs, trip assembly, collars and fulcrum pin
- "Sure Seal®" sand load bearing assembly
- Anti-backsplash arm
- Adjustable diffuser pin
- Adjustable deflector plate
- Dual or single nozzle
- Chemical-resistant bearing seals promote longer lifespan
- Stream straightening vane standard
- 25° angle of trajectory

Operating Ranges

Pressure: 30 to 60 PSI
 Flow: 3.94 to 13.73 GPM
 Spacing: 41 to 50 ft
 Trajectory: 23°
 Rotation: 20° to 340° or Full Circle

Specifications

- 3/4" male inlet, National Pipe Thread (NPT)
- Drive nozzle 1/4" – 18 NPT
- Filler nozzle 3/8" – 24 UNF

How to Specify

261SDX	10	PG
Model	Drive Nozzle	Filler Nozzle

Nozzle Code

Code	Inches	mm
06	3/32"	2.4
08	1/8"	3.2
10	5/32"	4.0
11	11/64"	4.4
12	3/16"	4.8
13	13/64"	5.2
14	7/32"	5.6
PG	Plug	



3/4" Full/Part Circle Brass Impact Sprinklers

261SDX Single Nozzle Performance

Single Nozzle	Pressure PSI	Radius Feet	Flow GPM
10 / PG	30	41	3.94
	35	42	4.35
	40	43	4.62
	45	44	4.90
	50	45	5.17
	55	45	5.44
11 / PG	60	46	5.64
	30	42	4.62
	35	43	5.03
	40	44	5.37
	45	45	5.64
	50	46	6.05
12 / PG	55	47	6.39
	60	47	6.53
	30	43	5.31
	35	44	5.84
	40	45	6.32
	45	46	6.66
13 / PG	50	47	7.01
	55	47	7.34
	60	48	7.68
	30	44	6.66
	35	45	7.21
	40	46	7.68
14 / PG	45	47	8.23
	50	48	8.70
	55	48	9.04
	60	49	9.38
	30	45	7.21
	35	46	7.75
14 / PG	40	47	8.29
	45	48	8.77
	50	49	9.31
	55	49	9.65
	60	50	10.21

261SDX Dual Nozzle Performance

Dual Nozzle	Pressure PSI	Radius Feet	Flow GPM
10 / 06	30	41	5.20
	35	42	5.73
	40	43	6.10
	45	44	6.46
	50	45	6.83
	55	45	7.16
11 / 06	60	46	7.43
	30	42	5.88
	35	43	6.41
	40	44	6.85
	45	45	7.20
	50	45	7.71
12 / 06	55	46	8.11
	60	47	8.32
	30	43	6.57
	35	44	7.32
	40	45	7.80
	45	46	8.22
12 / 08	50	47	8.67
	55	47	9.06
	60	48	9.47
	30	43	7.9
	35	44	8.63
	40	45	9.31
13 / 08	45	46	9.79
	50	47	10.41
	55	47	10.88
	60	48	11.28
	30	44	7.21
	35	45	7.75
14 / 08	40	46	8.29
	45	47	8.77
	50	48	9.31
	55	48	9.65
	60	49	10.21
	30	45	9.59
14 / 08	35	46	10.61
	40	47	11.28
	45	48	11.91
	50	49	12.58
	55	49	13.12
	60	50	13.73



1" Full/Part Circle Brass Impact Sprinklers

360SAX

Ideal for large landscape/ turf irrigation, pastures, logging, mining, waste water treatment, and dust control applications.

Features and Benefits

- Solid brass construction
- Stainless steel springs, collars and fulcrum pin
- "Sure Seal®" sand load bearing assembly
- Chemical-resistant bearing seals promote longer lifespan
- Adjustable diffuser pin
- Over-under nozzles
- Dual or single nozzle
- Cast brass trip assembly
- 23° angle of trajectory

Operating Ranges

Pressure: 35 to 100 PSI
 Flow: 7.75 to 44.01 GPM
 Throw: 49 to 77 ft radius
 Trajectory: 23°
 Rotation: 20° to 340° or Full Circle

Specifications

- 1" male inlet, National Pipe Thread (NPT)
- Drive nozzle 5/8" - 18 UNF
- Filler nozzle 3/8" - 24 UNF

How to Specify

360SAX	14	08
Model	Drive Nozzle	Filler Nozzle

Nozzle Code

Code	Inches
08	1/8"
14	7/32"
16	1/4"
18	9/32"
20	5/16"
22	11/32"
24	3/8"
PG	Plug



1" Full/Part Circle Brass Impact Sprinklers

360SA Single Nozzle Performance

Single Nozzle	Pressure PSI	Radius Feet	Flow GPM
14 / PG (7/32")	35	49	7.75
	40	51	8.29
	45	53	8.77
	50	55	9.31
	55	56	9.65
	60	58	10.21
	65	59	10.61
	70	60	10.94
	75	62	11.28
	80	63	11.69
	85	64	12.20
	90	66	13.54
95	66	13.91	
100	67	14.27	
16 / PG (1/4")	35	52	10.21
	40	54	10.94
	45	55	11.62
	50	57	12.24
	55	57	12.85
	60	58	13.32
	65	62	13.87
	70	63	14.34
	75	64	14.82
	80	65	15.31
	85	66	16.50
	90	67	17.68
95	68	18.16	
100	68	18.36	
18 / PG (9/32")	35	55	12.92
	40	57	13.94
	45	58	14.75
	50	60	15.43
	55	62	16.32
	60	65	17.01
	65	67	17.61
	70	70	18.29
	75	71	18.91
	80	72	19.52
	85	73	20.95
	90	74	22.38
95	74	22.99	
100	75	23.59	
20 / PG (5/16")	35	59	15.51
	40	59	16.72
	45	61	17.61
	50	63	18.63
	55	65	19.44
	60	67	20.33
	65	69	21.14
	70	71	21.96
	75	73	22.71
	80	75	23.46
	85	75	25.55
	90	76	24.63
95	77	28.38	
100	78	29.12	
22 / PG (11/32")	35	59	17.88
	40	60	19.11
	45	63	20.19
	50	65	21.28
	55	67	22.37
	60	69	23.46
	65	70	24.01
	70	72	25.22
	75	74	26.11
	80	76	26.99
	85	77	30.21
	90	79	33.43
95	80	34.34	
100	82	35.24	
24 / PG (3/8")	35	60	21.48
	40	62	23.12
	45	65	24.54
	50	67	25.97
	55	70	27.21
	60	73	28.35
	65	74	29.51
	70	75	30.53
	75	76	31.82
	80	77	32.77
	85	79	36.28
	90	80	39.78
95	82	40.86	
100	83	41.93	

360SA Dual Nozzle Performance

Dual Nozzle	Pressure PSI	Radius Feet	Flow GPM
14 / 08 (7/32" x 1/8")	35	49	10.61
	40	51	11.28
	45	53	11.91
	50	55	12.58
	55	56	13.12
	60	58	13.73
	65	59	14.21
	70	60	14.75
	75	62	15.23
	80	63	15.71
	85	64	16.21
	90	66	16.70
95	67	17.20	
100	67	17.69	
16 / 08 (1/4" x 1/8")	35	52	13.26
	40	54	14.07
	45	55	14.89
	50	57	15.84
	55	57	16.52
	60	58	17.06
	65	62	17.88
	70	63	18.56
	75	64	19.04
	80	65	19.72
	85	65	20.39
	90	67	21.05
95	68	21.72	
100	70	22.38	
18 / 08 (9/32" x 1/8")	35	55	15.43
	40	57	16.52
	45	58	17.54
	50	60	18.49
	55	62	19.31
	60	65	20.26
	65	67	21.01
	70	70	21.82
	75	71	22.57
	80	72	23.25
	85	74	24.00
	90	75	24.75
95	77	25.49	
100	78	26.24	
20 / 08 (5/16" x 1/8")	35	59	18.02
	40	59	19.38
	45	61	20.40
	50	63	21.35
	55	65	22.51
	60	67	23.52
	65	69	24.41
	70	71	25.36
	75	73	26.18
	80	75	26.99
	85	76	27.86
	90	77	29.73
95	78	31.59	
100	79	32.46	
22 / 08 (11/32" x 1/8")	35	59	20.19
	40	60	21.49
	45	63	23.05
	50	65	24.28
	55	67	25.56
	60	69	26.52
	65	70	27.54
	70	72	28.70
	75	74	29.37
	80	76	30.32
	85	77	33.57
	90	77	36.22
95	79	37.17	
100	80	38.12	
24 / 08 (3/8" x 1/8")	35	60	23.73
	40	62	25.22
	45	65	26.72
	50	67	28.83
	55	70	29.65
	60	73	30.80
	65	74	31.96
	70	75	35.05
	75	76	34.07
	80	77	35.36
	85	78	39.50
	90	79	42.64
95	80	43.78	
100	82	44.01	



1 1/4" Full/Part Circle Brass Impact Sprinklers

AI123

Ideal for large landscape/turf irrigation, pastures, logging, mining, waste water treatment, and dust control applications.

Features and Benefits

- Solid brass construction
- Stainless steel springs, collars and fulcrum pin
- Cast brass trip assembly
- "Sure Seal®" sand load bearing assembly
- Bearing assembly hood designed to ensure longevity
- Chemical-resistant bearing seals promote longer lifespan
- Over-under nozzles
- Dual or single nozzle
- 23° angle of trajectory

Operating Ranges

Pressure: 55 to 95 PSI
 Flow: 24.9 to 121 GPM
 Throw: 75 to 113 ft
 Trajectory: 23°
 Rotation: 20° to 340° or Full Circle

Specifications

- 1 1/4" male inlet, National Pipe Thread (NPT)
- Drive nozzle 1" - 20 UNEF
- Filler nozzle 1/8" - 27 NPT

How to Specify

AI123	14	08
Model	Drive Nozzle	Filler Nozzle

Nozzle Code

Nozzle Code	Inches	mm
PG	Plug	
14	7/32"	5.60
15	15/64"	6.00
16	1/4"	6.40
17	17/64"	6.70
18	9/32"	7.10
22	11/32"	8.70
24	3/8"	9.50
26	13/32"	10.30
28	7/16"	11.10
32	1/2"	12.70
34	17/32"	13.50
36	9/16"	14.30
40	5/8"	15.90



1 1/4" Full/Part Circle Brass Impact Sprinklers

AI123 Performance

23° Trajectory

Nozzle Code	Pressure PSI	Radius Feet	Flow GPM
22 / PG	55	73	24.9
	60	75	25.8
	65	77	26.9
	70	80	27.0
	75	81	28.9
	80	81	30.4
	85	81	31.1
	90	83	32.7
24 / PG	95	85	32.8
	55	75	29.6
	60	79	30.8
	65	81	32.0
	70	83	33.3
	75	85	34.7
	80	86	35.7
	85	87	36.0
26 / PG	90	89	38.3
	95	91	39.1
	55	75	32.9
	60	76	34.4
	65	77	35.8
	70	77	37.2
	75	77	38.5
	80	78	39.9
28 / PG	85	79	41.2
	90	79	42.3
	95	79	43.3
	55	83	39.7
	60	86	41.6
	65	87	43.3
	70	89	45.1
	75	90	46.8
32 / PG	80	91	48.0
	85	93	50.0
	90	95	51.5
	95	96	53.0
	55	89	50.7
	60	91	53.0
	65	93	55.3
	70	94	57.7
36 / PG	75	96	59.6
	80	101	63.0
	85	102	63.5
	90	103	65.3
	95	105	67.1
	55	96	63.2
	60	97	65.5
	65	99	69.4
40 / PG	70	101	72.2
	75	102	74.9
	80	104	77.5
	85	105	80.0
	90	106	82.2
	95	108	84.3
	55	97	84.9
	60	101	89.0
40 / PG	65	105	93.2
	70	107	96.5
	75	109	99.8
	80	110	102.9
	85	111	106.0
	90	112	109.3
	95	113	112.0

AI123 Performance

23° Trajectory

Nozzle Code	Pressure PSI	Radius Feet	Flow GPM
22 / 14	55	73	34.9
	60	75	36.5
	65	77	38.0
	70	80	38.8
	75	81	41.0
	80	81	42.6
	85	81	43.8
	90	83	44.0
24 / 14	95	85	45.6
	55	77	35.7
	60	79	37.2
	65	81	38.7
	70	83	40.2
	75	85	41.7
	80	85	43.2
	85	86	44.7
26 / 14	90	87	46.2
	95	87	46.9
	55	75	43.4
	60	76	46.6
	65	77	48.6
	70	77	50.4
	75	77	52.4
	80	78	54.3
28 / 14	85	79	56.0
	90	79	57.9
	95	79	59.6
	55	83	49.1
	60	86	51.5
	65	87	53.8
	70	89	55.9
	75	90	57.9
32 / 16	80	91	60.0
	85	93	62.0
	90	95	63.9
	95	96	65.8
	55	89	63.9
	60	91	67.0
	65	93	70.0
	70	94	72.6
36 / 16	75	96	75.4
	80	101	75.6
	85	102	80.5
	90	103	83.6
	95	105	85.0
	55	96	76.8
	60	97	80.5
	65	99	84.1
40 / 16	70	101	87.4
	75	102	90.7
	80	104	93.6
	85	105	96.9
	90	106	99.5
	95	108	102.0
	55	97	90.0
	60	101	94.7
40 / 16	65	105	99.2
	70	107	103.0
	75	109	107.0
	80	110	110.0
	85	111	114.0
	90	112	117.0
	95	113	121.0





POP UP SPRINKLERS & NOZZLES



Gravity Return Sprinkler

2" Pop-up spray head for residential and commercial properties where a moderately priced, high quality sprinkler is desired.

Features and Benefits

- Body constructed of cast red brass
- Inner body and spindle machined from yellow brass
- Metal-to-metal seating
- Accepts "B" series nozzles

Specifications

- Overall height: 4 3/4"
- Top diameter: 2 1/4"
- 1/2" NPT inlet
- Maximum pressure: 50 PSI
- Operating pressure: 15 to 30 PSI

Model Description

Model No.	Description
BPHM	1/2" NPT, Brass Pop-Up, 2" High



Gravity Return Sprinkler

Brass Pop-Up Sprinklers are available in shrub, quarter, half, full, and high options.

Features and Benefits

- Available in 1 1/4" and 2" pop-up action
- Body constructed of cast red brass
- Yellow brass nozzles with adjusting screw

Specifications

- 1/2" NPT inlet
- Flow Range: 0.90 to 4.00 GPM
- Operating pressure: 15 to 30 PSI

Model Description

Model No.	Description
18	Pop-Up Body Only
18HP	High Pop-Up Body Only
19	Shrub-Body Only
18SF	Pop-Up Full Spray
18SH	Pop-Up Half Spray
18SQ	Pop-Up Quarter Spray
SF	Brass Nozzle-15' Radius-Full Spray
SH	Brass Nozzle-15' Radius-Half Spray
SQ	Brass Nozzle-15' Radius-Quarter Spray



Spray Pattern

Insert #	Pressure PSI	Flow GPM	Radius ft	Precip (in/hr)	
				■	▲
SF Full 15'	15	3.20	12.00	2.14	2.49
	20	3.50	13.00	1.99	2.32
	25	3.70	14.00	1.82	1.99
	30	4.00	15.00	1.71	1.99
SH Half 15'	15	1.60	12.00	2.14	2.49
	20	1.90	13.00	2.17	2.52
	25	2.00	14.00	1.97	2.29
	30	2.20	15.00	1.88	2.19
SQ Quarter 15'	15	.90	12.00	2.41	2.80
	20	1.00	13.00	2.28	2.65
	25	1.10	14.00	2.16	2.51
	30	1.30	15.00	2.23	2.59
Center Strip	15	1.70	3'x17'	2.76	3.21
	20	2.10	3.5'x18'	2.76	3.21
	25	3.30	3.7'x19'	2.71	3.15
	30	2.50	4'x20'	2.58	3.01



Pop Up Sprinklers & Nozzles | CoalBrass Nozzles



CoalBrass™ Nozzles

CoalBrass Nozzles are the best way to water areas requiring precise control of spray patterns and even precipitation. A special coefficient of uniformity (CU) slot ensures matched water disbursement from the base of the sprinkler, all the way to the end of the radius. Durable charcoal-colored CoalBrass nozzles suitable for the harshest of applications.

Features and Benefits

- Available in 5', 8', 10', 12', or 15' radius
- Uniform spray patterns throughout the full radius with CU slot
- Handles freezing temperatures better than plastic
- Black CoalBrass looks like plastic, reducing threat of theft
- Matched precipitation across spray patterns and radius sizes
- End, center and side strip patterns available
- Brass adjusting screw and high-flow polypropylene filter
- Fits all Buckner spray pop-ups
- May be used on sprinklers accepting a 5/8" - 28 thread



Model Description

Model No.	Description
B5	5' Radius, 5° Trajectory
B8	8' Radius, Flat Trajectory
B10	10' Radius, 15° Trajectory
B12	12' Radius, 27° Trajectory
B15	15' Radius, 27° Trajectory
SBA	1/2" FIPT Inlet, Accepts "B" Series Nozzles

Operating Ranges

Pressure: 10 to 30 PSI
 Flow: 0.37 to 4.0 GPM
 Throw: 6 to 14.6 ft radius
 Trajectory: 0 to 27°



Nozzle Pattern

Code	Description	
F	Full circle	360°
H	Half circle	180°
T	One-third circle	120°
Q	Quarter circle	90°
TT	Two-thirds circle	240°
TQ	Three-quarter circle	270°
CST	Center strip	
EST	End strip	
SST	Side strip	







CoalBrass Nozzle Performance Chart





5 Radius 5° Trajectory Low Angle

Nozzle Code	Pressure PSI	Radius ft	Flow GPM	Precip (in/hr)	
				■	▲
B5H* 180° 	15	4	0.74	3.6	3.7
	20	5	0.9	3.4	3.5
	25	5	1.02	3.0	3.1
	30	6	1.16	2.8	2.9
B5T* 120° 	15	4	0.49	3.6	3.7
	20	5	0.59	3.4	3.5
	25	5	0.67	3.0	3.1
	30	6	0.77	2.8	2.9
B5Q* 90° 	15	4	0.37	3.6	3.7
	20	5	0.45	3.4	3.5
	25	5	0.51	3.0	3.1
	30	6	0.58	2.8	2.9





8 Radius 0° Trajectory Flat

Nozzle Code	Pressure PSI	Radius ft	Flow GPM	Precip (in/hr)	
				■	▲
B8F 360° 	15	6	1.5	3.0	3.4
	20	7	1.6	2.7	3.1
	25	8	1.8	2.4	2.7
	30	9	2.0	2.1	2.4
B8H 180° 	15	6	0.75	3.0	3.4
	20	7	0.80	2.7	3.1
	25	8	0.90	2.4	2.7
	30	9	1.0	2.1	2.4
B8T 120° 	15	6	0.51	3.0	3.4
	20	7	0.61	2.7	3.1
	25	8	0.66	2.4	2.7
	30	9	0.73	2.1	2.4
B8Q 90° 	15	6	0.38	3.0	3.4
	20	7	0.40	2.7	3.1
	25	8	0.45	2.4	2.7
	30	9	0.50	2.1	2.4







10 Radius 15° Trajectory Low Angle

Nozzle Code	Pressure PSI	Radius ft	Flow GPM	Precip (in/hr)	
				■	▲
B10F 360° 	15	7	1.6	2.3	2.6
	20	8	1.8	2.0	2.3
	25	9	2.0	1.7	2.0
	30	10	2.2	1.5	1.7
B10H* 180° 	15	7	0.80	2.3	2.6
	20	8	0.90	2.0	2.3
	25	9	1.0	1.7	2.0
	30	10	1.10	1.5	1.7
B10T* 120° 	15	7	0.53	2.3	2.6
	20	8	0.61	2.0	2.3
	25	9	0.66	1.7	2.0
	30	10	0.73	1.5	1.7
B10Q* 90° 	15	7	0.40	2.3	2.6
	20	8	0.45	2.0	2.3
	25	9	0.50	1.7	2.0
	30	10	0.55	1.5	1.7



12 Radius 27° Trajectory Standard

Nozzle Code	Pressure PSI	Radius ft	Flow GPM	Precip (in/hr)	
				■	▲
B12F 360° 	15	10	1.6	1.5	1.8
	20	10.5	1.8	1.6	1.8
	25	11	2.0	1.6	1.8
	30	12	2.2	1.7	1.7
B12TQ* 270° 	15	10	1.04	1.5	1.8
	20	10.5	1.2	1.6	1.8
	25	11	1.32	1.6	1.8
	30	12	1.46	1.7	1.7
B12H* 180° 	15	10	0.80	1.5	1.8
	20	10.5	0.90	1.6	1.8
	25	11	1.0	1.6	1.8
	30	12	1.1	1.7	1.7
B12T* 120° 	15	10	0.52	1.5	1.8
	20	10.5	0.61	1.6	1.8
	25	11	0.66	1.6	1.8
	30	12	0.73	1.7	1.7
B12Q* 90° 	15	10	0.40	1.5	1.8
	20	10.5	0.45	1.6	1.8
	25	11	0.50	1.6	1.8
	30	12	0.55	1.7	1.7

15 Radius 27° Trajectory Standard

Nozzle Code	Pressure PSI	Radius ft	Flow GPM	Precip (in/hr)	
				■	▲
B15F 360° 	15	11.5	2.8	2.0	2.4
	20	12	3.3	1.6	1.8
	25	14	3.6	1.6	1.8
	30	14.6	4.0	1.7	1.7
B15TQ* 270° 	15	11.5	2.1	2.0	2.4
	20	12	2.47	1.6	1.8
	25	14	2.7	1.6	1.8
	30	14.6	3.0	1.7	1.7
B15TT* 240° 	15	11.5	1.9	2.0	2.4
	20	12	2.2	1.6	1.8
	25	14	2.4	1.6	1.8
	30	14.6	2.6	1.7	1.7
B15H* 180° 	15	11.5	1.4	2.0	2.4
	20	12	1.65	1.6	1.8
	25	14	1.8	1.6	1.8
	30	14.6	2.0	1.7	1.7
B15T* 120° 	15	11.5	0.95	2.0	2.4
	20	12	1.1	1.6	1.8
	25	14	1.2	1.6	1.8
	30	14.6	1.3	1.7	1.7
B15Q* 90° 	15	11.5	0.70	2.0	2.4
	20	12	0.82	1.6	1.8
	25	14	0.90	1.6	1.8
	30	14.6	1.0	1.7	1.7

15 Radius 30° Trajectory Standard

Nozzle Code	Pressure PSI	Radius ft	Flow GPM	Precip (in/hr)	
				■	▲
B15SST* 	1.0	4x26	0.9	1.7	
	1.4	4x28	1.0	1.7	
	1.7	4x28	1.1	1.9	
	2.0	4x30	1.2	1.9	
B15CST* 	1.0	4x26	0.9	1.7	
	1.4	4x28	1.0	1.7	
	1.7	4x28	1.1	1.9	
	2.0	4x30	1.2	1.9	
B15EST* 	1.0	4x26	0.45	1.7	
	1.4	4x28	0.50	1.7	
	1.7	4x28	0.55	1.9	
	2.0	4x30	0.60	1.9	



Nozzles & Drain Valves



SWEEPNOZ6
6" NPT, Sweeper Nozzle



SWEEPNOZ2
2" NPT, Sweeper Nozzle



GS10
Greens Spray Nozzle, 1" Female
Hose Inlet



BDV
Brass drain valve, 1/2" Male NPT

- Installed at a 45° angle
- Opens automatically below 4 PSI
- Allows water to drain out of pipe
- Brass-to-brass seat

Sprinkler Bases & Roller Bases



RB1507
15" Metal Roller Base, 3/4"
Hose, accepts 3/4" Male NPT
Sprinkler



RB2210
22" Metal Roller Base, 1" Hose,
accepts 1" Male NPT Sprinkler



WB05
Wire base 1/2" FIPT outlet



WB07
Wire base 3/4" FIPT outlet

Spike Base



SPIKEA
Zinc one-way spike



SPIKEB
Zinc step sprinkler spike
(2-way with cap)





HOSE END



Hose End | Hose & Pipe Fittings



5
Hose Fitting 3/4" Female Hose x
1/2" Male NPT



7
Hose Fitting 3/4" Female Hose x
3/4" Female Hose



8
Hose Fitting 3/4" Male Hose x
3/4" Male x 1/2" Female NPT



9
Hose Fitting 3/4" Female Hose x
3/4" Male x 1/2" Female NPT



10
Non-swivel fitting 3/4" Male HT x
1/2" female NPT



12
Hose Fitting 3/4" Female Hose x
3/4" Female NPT



13
Hose Fitting 3/4" Female Hose x
1/2" Female NPT



14
Hose Cap 3/4" Female HT



HA10
Non-swivel fitting
3/4" male HT x 1" Female HT



Y Stainer

Features and Benefits

- Available in 1/2" to 2"
- Heavy duty brass construction
- 20 mesh stainless steel wire screen
- Tapped cap with plug
- Rated up to 200 PSI WOG

Model Description

Model No.	Size
BYS050	1/2"
BYS075	3/4"
BYS100	1"
BYS125	1 1/2"
BYS150	1 3/4"
BYS200	2"



Service Accessories



Pressure Gauge

PG200

0 to 200 PSI with 3/4" FHT Swivel



Pitot Tube

TPT

1/4" NPT inlet



Nipple Extractor

NEP050C

Nipple Extractor for 1/2" Nipple





ANTI-SIPHON & HOSE END PRODUCTS CROSS REFERENCE



Anti-Siphon & Hose End Products Cross Reference

Superior Part #	Aqualine Part #	Champion Part #	Superior Part Description
5	HPF5	-	Hose Fitting 3/4" Female Hose x 1/2" Male NPT
7	HPF7	-	Hose Fitting 3/4" Female Hose x 3/4" Female Hose
8	HPF8	-	Hose Fitting 3/4" Male Hose x 3/4" Male x 1/2" Female NPT
9	HPF9	-	Hose Fitting 3/4" Female Hose x 3/4" Male 1/2" Female NPT
10	HPF10	-	Hose Fitting 3/4" Male Hose x 1/2" Male NPT
12	HPF12	-	Hose Fitting 3/4" Female Hose x 3/4" Female NPT
13	HPF13	-	Hose Fitting 3/4" Female Hose x 1/2" Female NPT
14	HPF14	-	Hose Cap 3/4" Female
18	BLR	18	Red Brass Pop-Up Body Only
19	BS	19	Red Brass Shrub-Body Only
18HP	BHR	18HP	Red Brass High Pop-Up Body Only
18SF	-	18SF	Red Brass Pop-Up Full Spray
18SH	-	18SH	Red Brass Pop-Up Half Spray
18SQ	-	18SQ	Red Brass Pop-Up Quarter Spray
ASB07	-	V19-466P-075	3/4" NPT, brass anti-siphon body
ASB07Y	600	V19-466P-075Y	Anti-Siphon Body 3/4" Yellow Brass
ASB10	-	V19-466P-100	1" NPT, brass anti-siphon body
ASB10Y	602	V19-466-100Y	Anti-Siphon Body 1" Yellow Brass
ASBU07	-	V19-466-075	3/4" NPT, brass anti-siphon body w/union
ASBU07Y	601	466-075Y	Anti-Siphon Body With Union 3/4" Yellow Brass
ASBU10	-	V19-466-100	1" NPT, brass anti-siphon body w/union
ASBU10Y	603	V19-466-100Y	Anti-Siphon body With Union 1" Yellow Brass
ASV07	-	466P-075	3/4" NPT, brass anti-siphon valve
ASV07Y	AS-075	466P-075Y	Anti-Siphon Valve, 3/4" Yellow Brass
ASV10	-	466P-100	1" NPT, brass anti-siphon valve
ASV10Y	AS-100	466P-100Y	Anti-Siphon Valve, 1" Yellow Brass
ASVU07	-	466-075	3/4" NPT, brass anti-siphon valve w/union
ASVU07Y	ASU-075	466-075Y	Anti-Siphon Valve With Union 3/4"
ASVU10	-	466-100	1" NPT, brass anti-siphon valve w/union
ASVU10Y	ASU-100	466-100Y	Anti-Siphon Valve W/Union 1" Yellow Brass
AV075	-	200RS-075	3/4" Angle Vavle with Cross Handle - Red Brass
AV075Y	AV-075	200RS-075Y	3/4" Angle Valve with Cross Handle - Yellow Brass
AV100	-	200RS-100	1" Angle Valve with Cross Handle - Red Brass
AV100Y	AV-100	200RS-100Y	1" Angle Valve with Cross Handle - Yellow Brass
AV120	-	200RS-125	1-1/4" Angle Valve with Cross Handle - Red Brass
AV120Y	AV-125	200RS-125Y	1-1/4" Angle Valve with Cross Handle - Yellow Brass
AV150	-	200RS-150	1-1/2" Angle Valve with Cross Handle - Red Brass
AV150Y	AV-150	200RS-150Y	1-1/2" Angle Valve with Cross Handle - Yellow Brass
AV200	-	200RS-200	2" Angle Valve with Cross Handle - Red Brass
AV200Y	AV-200	200RS-200Y	2" Angle Valve with Cross Handle - Yellow Brass
AVB07	-	262-075	3/4" NPT, Atmospheric Vacuum Breaker
AVB07Y	AVB-075	262-075Y	3/4" Atmospheric Vcauum Breaker - Yellow Brass
AVB10	-	262-100	1" NPT, Atmospheric Vacuum Breaker
AVB10Y	AVB-100	262-100Y	1" NPT, Atmospheric Vacuum Breaker - Yellow Brass
AVB12	-	262-125	Atmospheric Vacuum Breaker 1.25" - Red Brass
AVB12Y	AVB-125	262-125Y	Atmospheric Vacuum Breaker 1.25" - Yellow Brass
AVB15	-	262-150	Atmospheric Vacuum Breaker 1.5" - Red Brass
AVB15Y	AVB-150	262-150Y	Atmospheric Vacuum Breaker 1.5" - Yellow Brass
AVB20	-	262-200	Atmospheric Vacuum Breaker 2" - Red Brass
AVB20Y	AVB-200	262-200Y	Atmospheric Vacuum Breaker 2" - Yellow Brass
AVBU07	-	362-075	3/4" NPT, Atmospheric Vacuum Breaker w/Union
AVBU07Y	AVBU-075	362-075Y	3/4" NPT, Atmospheric Vacuum Breaker w/Union - Yellow Brass
AVBU10	-	362-100	1" NPT, Atmospheric Vacuum Breaker w/Union
AVBU10Y	AVBU-100	362-100Y	1" NPT, Atmospheric Vacuum Breaker w/Union - Yellow Brass
AVBU12	-	362-125	Atmospheric Vacuum Breaker w/Union 1.25"
AVBU12Y	AVBU-125	362-125Y	Atmospheric Vacuum Breaker w/Union 1.25" - Yellow Brass
AVBU15	-	362-150	Atmospheric Vacuum Breaker w/Union 1.5"
AVBU15Y	AVBU-150	362-150Y	Atmospheric Vacuum Breaker w/Union 1.5" - Yellow Brass
AVBU20	-	362-200	Atmospheric Vacuum Breaker w/Union 2"
AVBU20Y	AVBU-200	362-200Y	Atmospheric Vacuum Breaker w/Unioni 2" - Yellow Brass
AVU075	-	300RS-075	Angle Valve w/Union 3/4" - Red Brass
AVU075Y	AVU-075	300RS-075Y	Angle Valve w/Union 3/4" - Yellow Brass
AVU100	-	300RS-100	Angle Valve w/Union 1" - Red Brass
AVU100Y	AVU-100	300RS-100Y	Angle Valve w/Union 1" - Yellow Brass
AVU120	-	300RS-125	Angle Valve w/Union 1.25" - Red Brass
AVU120Y	AVU-125	300RS-125Y	Angle Valve w/Union 1.25" - Yellow Brass



Anti-Siphon & Hose End Products Cross Reference

Superior Part #	Aqualine Part #	Champion Part #	Superior Part Description
AVU150	-	300RS-150	Angle Valve w/Union 1.5" - Red Brass
AVU150Y	AVU-150	300RS-150Y	Angle Valve w/Union 1.5" - Yellow Brass
AVU200	-	300RS-200	Angle Valve w/Union 2" - Red Brass
AVU200Y	AVU-200	300RS-200Y	Angle Valve w/Union 2" - Yellow Brass
ASVUW07Y	ASUW-075	466W-075Y	Anti-Siphon Valve w/Union, Wheel Handle 3/4"
ASVUW10Y	ASUW-100	466W-100Y	Anti-Siphon Valve w/Union, Wheel Handle 1"
ASVW07Y	ASW-075	466PW-075Y	Anti-Siphon Valve w/Wheel Handle 3/4"
ASVW10Y	ASW-100	466PW-100Y	Anti-Siphon Valve w/Wheel Handle 1"
B400	-	B-400	Garden Valve Bent Nose 3/4" Mht X 1/2" Fnpt - Red Brass
B400Y	GV-050	B-401	Garden Valve 3/4" Mht X 1/2" Fnpt - Yellow Brass
B401	-	B-401LK	Garden Valve 3/4" x 3/4" Female NPT
B401LK	GV-075L	B-400LK	Garden Valve 3/4" x 3/4" Female NPT Loose Key
B401Y	GV-075	-	Garden Valve 3/4" Mht 3/4" Fnpt - Yellow Brass
B402	-	B-402	Garden Valve 3/4" x 1" Female NPT
B402LK	GV-100L	B-402lk	Garden Valve 3/4" x 1" Female NPT Loose Key
B402Y	GV-100	-	Garden Valve 3/4" Mht X 1" Fnpt - Yellow Brass
BDV	-	DV-050	Valve, Ball Drain 1/2"
BPHM	BHR	18HP	1/2" NPT, Brass Pop-Up, 2" High
BPM	BLR	18	1/2" NPT, Brass Pop-Up, 1" High
GS10	-	-	Greens Spray Nozzle, 1" Female Hose Inlet
HA10	-	-	Hose Adaptor Kit 3/4" to 1" Hose Thread
HB1F	-	HB-1F-D	Hose Bibb 3/4" x 1/2" Female NPT
HB1FY	HB-050F	-	Hose Bibb 3/4" MHT X 1/2" Fnpt - Yellow Brass
HB1M	-	HB-1M	Hose Bibb 3/4" x 1/2" Male NPT
HB1MY	HB-050M	-	Hose Bibb 3/4" x 1/2" X Male NPT - Yellow Brass
HB2F	-	HB-2F	Hose Bibb 3/4" x 3/4" Female NPT
HB2FY	HB-075F	-	Hose Bibb 3/4" Mht X 3/4" Fnpt - Yellow Brass
HB2M	-	HB-2M	Hose Bibb 3/4" x 3/4" Male NPT
HB2MY	HB-075M	-	Hose Bibb 3/4" Mht X 3/4" Fnpt - Yellow Brass
I400	-	I-400	Garden Valve Inverted 3/4" x 1/2" Female Pipe Thread
I400Y	GV-050IN	-	Garden Valve Inverted 3/4" MHT X 1/2" Fnpt - Yellow Brass
I401	-	I-401	Inv. Garden Valve 3/4" x 3/4" Female NPT
I401LK	-	I-401LK	Inv. Garden Valve 3/4" x 3/4" Female NPT Loose Key
I401LKY	GV-050INL	-	Garden Valve Inverted Loose Key 3/4" Mht X 3/4" Fnpt - Yellow Brass
I401Y	GV-075IN	-	Garden Valve Inverted 3/4" Mht X 3/4" Fnpt - Yellow Brass
I402	-	I-402	Inv. Garden Valve 3/4" x 1" Female NPT
I402Y	GV-100IN	-	Garden Valve Inverted 3/4" Mht X 1" Fnpt - Yellow Brass
NEP050C	NE-ZINC	-	Nipple Extractor for 1/2" Nipple
PG200	PG200L	G200-C	Pressure Gauge, 0-200 PSI, 3/4" FHT Swivel
RB1507	-	-	15" Metal Roller Base, 3/4" Hose, accepts 3/4" Male NPT Sprinkler
RB2210	-	-	22" Metal Roller Base, 1" Hose, accepts 1" Male NPT Sprinkler
RK-30C	RK1	RK-30C	3/4" Anti-Siphon Valve Rebuild Kit
RK-31C	RK2	RK-31C	1" Anti-Siphon Valve Rebuild Kit
RK-6C	RK4	RK-6C	3/4" Vacuum Breaker Rebuild Kit
RK-7C	RK5	RK-7C	1" Vacuum Breaker Rebuild Kit
SBA	BHR-M	-	Brass, 1/2" FIPT Inlet, Accepts "B" Series Nozzles
SF	F15	SF	Brass Nozzle - 15' Radius-Half Spray
SH	H15	SH	Brass Nozzle - 15' Radius-Half Spray
SK30	30VK	30-6	Manual Valve Key 30" Handle
SK54	54VK	30-30	Manual Valve Key 54" Handle
SK6	7VK	30-54	Manual Valve Key 6" Handle
SPIKEA	-	-	Metal Step Sprinkler Base, 1/2" FNPT outlet by 3/4" MHT inlet
SPIKEB	-	-	Metal Step Sprinkler Base, 1/2" FNPT outlet by 3/4" FHT & MHT inlet
SQ	Q15	SQ	Brass Nozzle - 15' Radius-Quarter Spray
SS	CS	SS	Brass Nozzle - 4' x 20' Center Strip Spray
SWEEPNOZ2	HN-2	34	2" NPT, Sweeper Nozzle
SWEEPNOZ6	HN-6	35	6" NPT, Sweeper Nozzle
TLK	QC-LK	LK	Key for lock top quick coupling valves & valve markers
TPT	-	-	Large Pitot Tube
TWISTNOZ3	-	-	3" NPT, Twist Nozzle
TWISTNOZ4	HN-4	-	4" NPT, Twist Nozzle
TWISTNOZ7	HN-7	-	7" NPT, Twist Nozzle
VBH	HEVB	VBH	Hose Bibb Vacuum Breaker 3/4"
WB05	-	-	1/2" FIPT outlet x 3/4" FHT Swivel Wire Base
WB07	-	-	3/4" FIPT outlet x 3/4" FHT Swivel Wire Base





Superior Limited Trade Warranty

Superior warrants to its trade customers that its products will be free from original defects in material and workmanship for a period of time (commencing on the date of original sale to the trade customer) as follows:

3 YEARS for all Superior Brass trademarked products, which include:

- Brass/Plastic body valves
- Brass/Plastic automatic adaptors
- Brass quick coupling valves, keys, and hose swivels
- Brass manual angle valves
- Brass above-ground impact sprinklers
- Brass spray nozzles
- Sterling controllers

2 YEARS for all other products.

Note: Solenoids and pressure gauges are warranted for three years.

This warranty applies only to Superior products which are installed as specified and used as intended for irrigation purposes. This warranty applies only to cataloged products which have not been altered, converted, damaged, misused, or misapplied. This warranty does not cover products adversely affected by the system into which the products are incorporated, including improperly designed, installed, operated, or maintained systems, or systems using water containing corrosive chemicals, electrolytes, sand, dirt, silt, rust, and scale. This warranty does not cover component failures caused by lightning strikes, electrical power surges, or damage caused by freezing environments. Superior's liability is limited to the repair and/or replacement at Superior's sole discretion, of products which are returned prepaid through the trade customer to the factory and found by Superior to be defective, but in no event shall Superior's liability exceed the selling price of the product.

Superior makes no other warranties, expressed or implied. No representative, agent, or distributor or other persons has the authority to waive, alter, or add to the printed provisions of this warranty, or to make representation of warranty not contained herein. The sole and exclusive remedy against Superior is limited to repair or replacement; Superior is not liable for consequential, incidental, indirect, or special damages, including but not limited to labor to inspect, remove, or replace products, vegetation loss, costs of substitute equipment or services, property damage, loss of use or loss of profits; nor is Superior liable for economic losses, lost profits, consequential damages or damage to property arising out of Superior's negligence or based on strict liability in tort.

The user and/or trade customer agrees to the limitations and exclusion of liability of this warranty by purchase or use of Superior products.

Some states do not permit the exclusion or limitation of incidental or consequential damages or of implied warranties. Therefore, some of the exclusions or limitations may not apply to you.

Superior reserves the right to redesign, alter or modify its products and shall incur no liability if a trade customer's inventory of Superior goods becomes obsolete. Alterations, modifications, and redesign of a product shall not be evidence that the previous product design was defective and the user and/or trade customer so agrees by purchase or use of Superior products.

23201 Normandie Avenue
Torrance, California 90501

Phone: 1.800.210.2525
www.getsuperior.com





SUPERIOR

23201 Normandie Avenue
Torrance, California 90501

www.getsuperior.com